

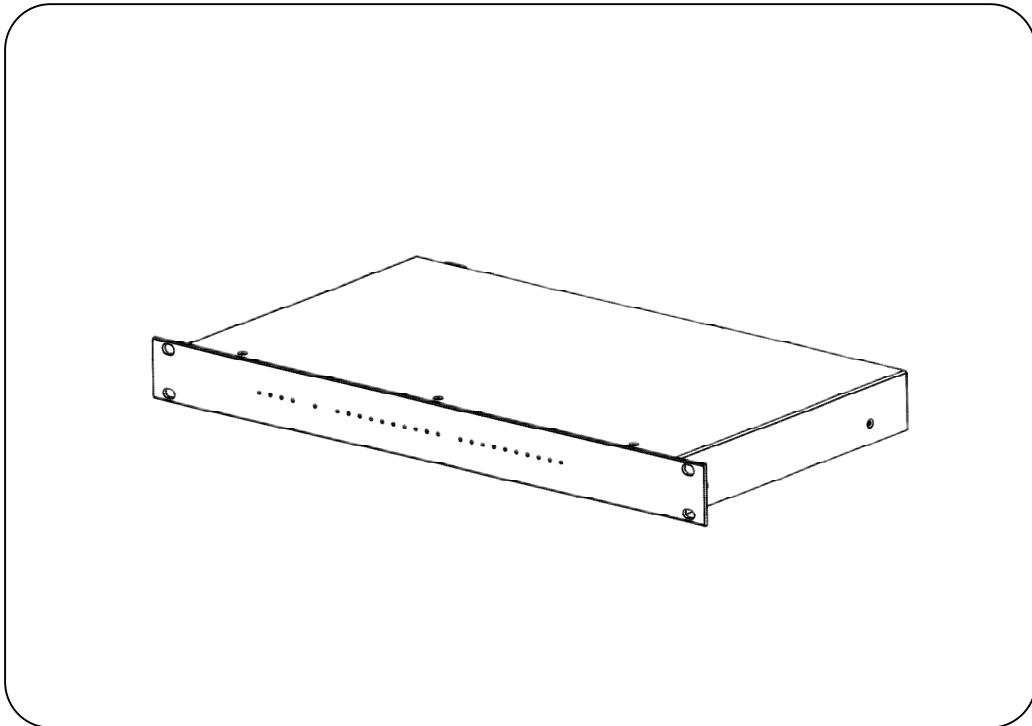

INSTRUCTION MANUAL

ZONE EXPANDER

VX-1010ZE



Thank you very much for purchasing TOA VX-1010ZE product.
Please read the instructions in this manual carefully, to ensure long-term, trouble-free operation of the system.

TABLE OF CONTENTS

TABLE OF CONTENTS	2
1 SAFETY PRECAUTIONS	3
2 PRODUCT INTRODUCTION.....	5
3 WIRING	8
4 APPENDIX	12

1 SAFETY PRECAUTIONS

- Before installation or use, be sure to carefully read all the instructions in this section for correct and safe operation.
- Be sure to follow all the precautionary instructions in this section, which contain important warnings and/or cautions regarding safety.
- After reading, keep this manual handy for future reference.

Safety Symbol and Message Conventions

Safety symbols and messages described below are used in this manual to prevent bodily injury and property damage which could result from mishandling. Before operating your product, read this manual first and understand the safety symbols and messages so you are thoroughly aware of the potential safety hazards.



WARNING

Indicates a potentially hazardous situation which, if mishandled, could result in death or serious personal injury.

When Installing the Unit

- Do not expose the unit to rain or an environment where it may be splashed by water or other liquids, as doing so may result in fire or electric shock.
- Use the unit only with the voltage specified on the unit. Using a voltage higher than that which is specified may result in fire or electric shock.
- Do not cut, kink, otherwise damage nor modify the power supply cord. In addition, avoid using the power cord in close proximity to heaters, and never place heavy objects -- including the unit itself -- on the power cord, as doing so may result in fire or electric shock.

When the Unit is in Use

- Should the following irregularity be found during use, immediately switch off the power, disconnect the power supply plug from the AC outlet and contact your nearest TOA dealer. Make no further attempt to operate the unit in this condition as this may cause fire or electric shock.
 - If you detect smoke or a strange smell coming from the unit
 - If water or any metallic object gets into the unit
 - If the unit falls, or the unit case breaks
 - If the power supply cord is damaged (exposure of the core, disconnection, etc.)
 - If it is malfunctioning (no tone sounds)
- To prevent a fire or electric shock, never open nor remove the unit case as there are high voltage components inside the unit. Refer all servicing to qualified service personnel.
- Do not place cups, bowls, or other containers of liquid or metallic objects on top of the unit. If they accidentally spill into the unit, this may cause a fire or electric shock.
- Do not insert nor drop metallic objects or flammable materials in the ventilation slots of the unit's cover, as this may result in fire or electric shock.
- Do not touch a plug during thunder and lightning, as this may result in electric shock.



CAUTION

Indicates a potentially hazardous situation which, if mishandled, could result in moderate or minor personal injury, and/or property damage.

When Installing the Unit

- Never plug in nor remove the power supply plug with wet hands, as doing so may cause electric shock.
- When unplugging the power supply cord, be sure to grasp the power supply plug; never pull on the cord itself. Operating the unit with a damaged power supply cord may cause a fire or electric shock.
- When moving the unit, be sure to remove its power supply cord from the wall outlet. Moving the unit with the power cord connected to the outlet may cause damage to the power cord, resulting in fire or electric shock. When removing the power cord, be sure to hold its plug to pull.
- Avoid installing the unit in humid or dusty locations, in locations exposed to the direct sunlight, near the heaters, or in locations generating sooty smoke or steam as doing otherwise may result in fire or electric shock.

- To avoid electric shocks, be sure to switch off the unit's power when connecting speakers.
- Be sure to follow the instructions below when rack-mounting the unit. Failure to do so may cause a fire or personal injury.
- Install the equipment rack on a stable, hard floor. Fix it with anchor bolts or take other arrangements to prevent it from falling down.
- When connecting the unit's power cord to an AC outlet, use the AC outlet with current capacity allowable to the unit.
- Rack-mounting screws are not supplied with the unit. Prepare them that are appropriate for the equipment rack.

When the Unit is in Use

- Use the dedicated AC adapter or its equivalent for the unit. Note that the use of other adapter may cause a fire.
- Contact your TOA dealer as to the cleaning. If dust is allowed to accumulate in the unit over a long period of time, a fire or damage to the unit may result.
- If dust accumulates on the power supply plug or in the wall AC outlet, a fire may result. Clean it periodically. In addition, insert the plug in the wall outlet securely.
- Switch off the power, and unplug the power supply plug from the AC outlet for safety purposes when cleaning or leaving the unit unused for 10 days or more. Doing otherwise may cause a fire or electric shock.

2 PRODUCT INTRODUCTION

2.1 Overview

The zone expander is a broadcast zone expansion device, shall use together with VX-1000 series Matrix Controller (VX-1000MC) and power amplifiers such like Peering Frame (VX-1000PF) and Power Amplifier Module (VX-1250DA/VX-1500DA) or Power Amplifier (DA-X1000S). It supports 2 levels of priority (General priority and Emergency priority) channels Power Amplifier inputs and supports 10-channels speaker zone expansion. The system can be connected up to 16 Zone Expanders with total of 160 zones.

VX-1010ZE Zone Expander:

- (1) Standard 1U rack-mount design, small, sturdy and durable.
- (2) Each device can be expanded to 10 speaker zones per unit, and maximum 16 Zone Expanders can be connected.
- (3) Support 10 control inputs and 1 emergency control input.
- (4) The front panel is equipped with status indicator LEDs to display the status of unit.
- (5) Supports monitoring functions such as open circuit, short circuit, and power amplifier failure of speaker lines based on the Matrix Controller (VX-1000MC). It also has a fuse failure protection function. When the fuse of the zone channel is blown, the indicator LED of the corresponding channel will be on.

2.2 Interface Description

[Front]

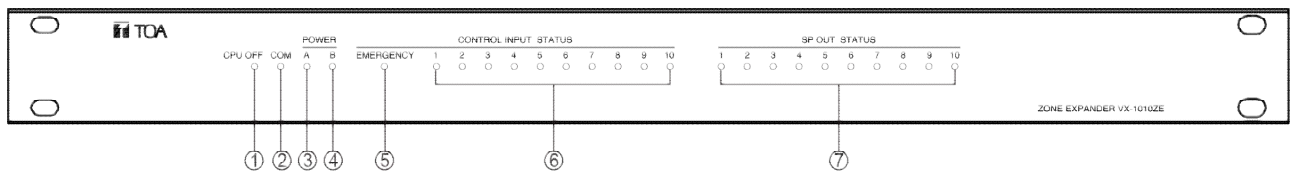





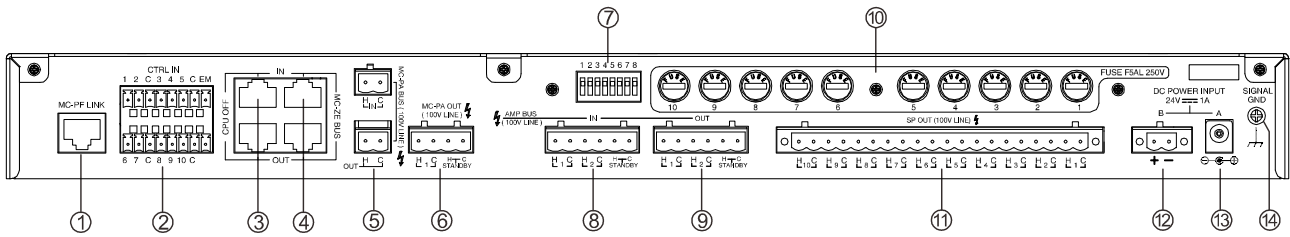









- ① CPU OFF LED: The Matrix Controller (VX-1000MC) initiates the CPU OFF broadcast, and the orange LED is on; Non-CPU OFF broadcast, no LED.
- ② COM LED: The Matrix Controller (VX-1000MC) communicates with the Zone Expander (VX-1010ZE), and the green LED is on; No communication, no LED.
- ③ POWER A LED: The Power Supply A interface is powered on, and the green LED is on. No power is no LED.
- ④ POWER B LED: The Power Supply B interface is powered on, and the green LED is on. No power is no LED.
- ⑤ EMERGENCY LED: Emergency broadcast status LED. When “C-EM” terminal is closed which is “Emergency Priority” broadcast is on, the red LED is on. When “C-EM” terminal is opened, the LED is off.
- ⑥ CONTROL INPUT STATUS: Control input 1~10 status LEDs. When the control input is closed, the corresponding status LED turns to red. When the control input is opened, the corresponding status LED is off.
- ⑦ SP OUT STATUS LED: Speaker Line Output 1~10 status LED. When a General Priority level's broadcast is in operation, the corresponding status LED turns to green, when an Emergency Priority level's broadcast is in operation, the corresponding status LED turns to red. When the fuse is blown, then the corresponding status LED turns to orange.

[Rear]



- ① MC-PF LINK Interface: It is connected to “MC-PF LINK” interface of the Peering Frame (VX-1000PF), which can perform amplifier surveillance and control, power supply surveillance and control, signal communication detection, etc.
- ② CTRL IN interface: 10 control inputs and 1 emergency control input. (1-10: control input port, EM: emergency control input port, C: common port) The 10-channel control input is a common short-circuit input, which can be used for event triggering of the VX-1000 system, which can be set by the VX-1000 Setting Software. For EM input, when EM is closed, the channel 1 of AMP BUS signal is used for all speaker line output channels.
- ③ CPU OFF cascade interface: cascade with the CPU OFF interface of the Matrix Controller (VX-1000MC), or cascade with the CPU OFF interface of another Zone Expander (VX-1010ZE).
- ④ MC-ZE BUS interface: The RJ45 port is connected to the “MC-PF LINK” interface of the Matrix Controller (VX-1000MC), or cascaded with the “MC-ZE BUS” port of another Zone Expander (VX-1010ZE).
- ⑤ MC-PA BUS interface: It is surveillance tone BUS, one channel of surveillance tone BUS input is connected to the “SP OUT” interface of the Matrix Controller (VX-1000MC). One channel of surveillance tone BUS output is connected to the “MC-PA BUS” interface of another Zone Expander (VX-1010ZE). It is used for Surveillance function of VX-1000 system. (H: hot, C: cold)
- ⑥ MC-PA OUT interface: Amplifier signal feedback for Matrix Controller (VX-1000MC), connected with the “PA IN” interface of the Matrix Controller (VX-1000MC). It is used for Surveillance function of VX-1000 system. (H: hot, C: cold)
- ⑦ DIP switch: The first four digits are the ID of the Zone Expander (VX-1010ZE), consists of 0000-1111 (0-16), and the last four digits are reserved. For the description of DIP switch settings, please refer to "2.2.1 DIP Switch Settings" below.
- ⑧ AMP BUS IN interface: Amplifier connection BUS. There are 2 power amplifier inputs, and 1 for Standby amplifier. Channel 1 is for an Emergency Priority level signal, channel 2 is for a General Priority level signal. When EM signal of CTRL IN interface is closed, all speaker line output channels have channel 1 signal.
- ⑨ AMP BUS OUT interface: It is cascade connection with “AMP BUS IN” interface. It is connected to another Zone Expander (VX-1010ZE).
- ⑩ Fuse holder: F5AL/250V, providing power amplifier output overcurrent protection.
- ⑪ SP OUT interface: 10 Speaker Line Outputs, which are connected to 100V high-impedance speakers. (H: hot, C: cold)
- ⑫ DC POWER INPUT B interface: Connect to a general power supply which supplies DC24/1A.
- ⑬ DC POWER INPUT A interface: Connect to an AC adapter which supplies DC24V/1A.
- ⑭ SIGNAL GND: Connect to the ground.

2.2.1 DIP Switch Settings

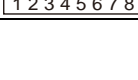
DIP number Device ID	1	2	3	4	VX-1010ZE
1	ON	ON	ON	ON	
2	OFF	ON	ON	ON	
3	ON	OFF	ON	ON	
4	OFF	OFF	ON	ON	
5	ON	ON	OFF	ON	
6	OFF	ON	OFF	ON	
7	ON	OFF	OFF	ON	
8	OFF	OFF	OFF	ON	
9	ON	ON	ON	OFF	
10	OFF	ON	ON	OFF	
11	ON	OFF	ON	OFF	
12	OFF	OFF	ON	OFF	
13	ON	ON	OFF	OFF	
14	OFF	ON	OFF	OFF	
15	ON	OFF	OFF	OFF	
16	OFF	OFF	OFF	OFF	

3 WIRING

3.1 System Wiring Diagram

3.1.1 Dual-channel wiring diagram (Connect 2 power amplifiers)

Example of 3 VX-1010ZE, 30 speaker-out lines

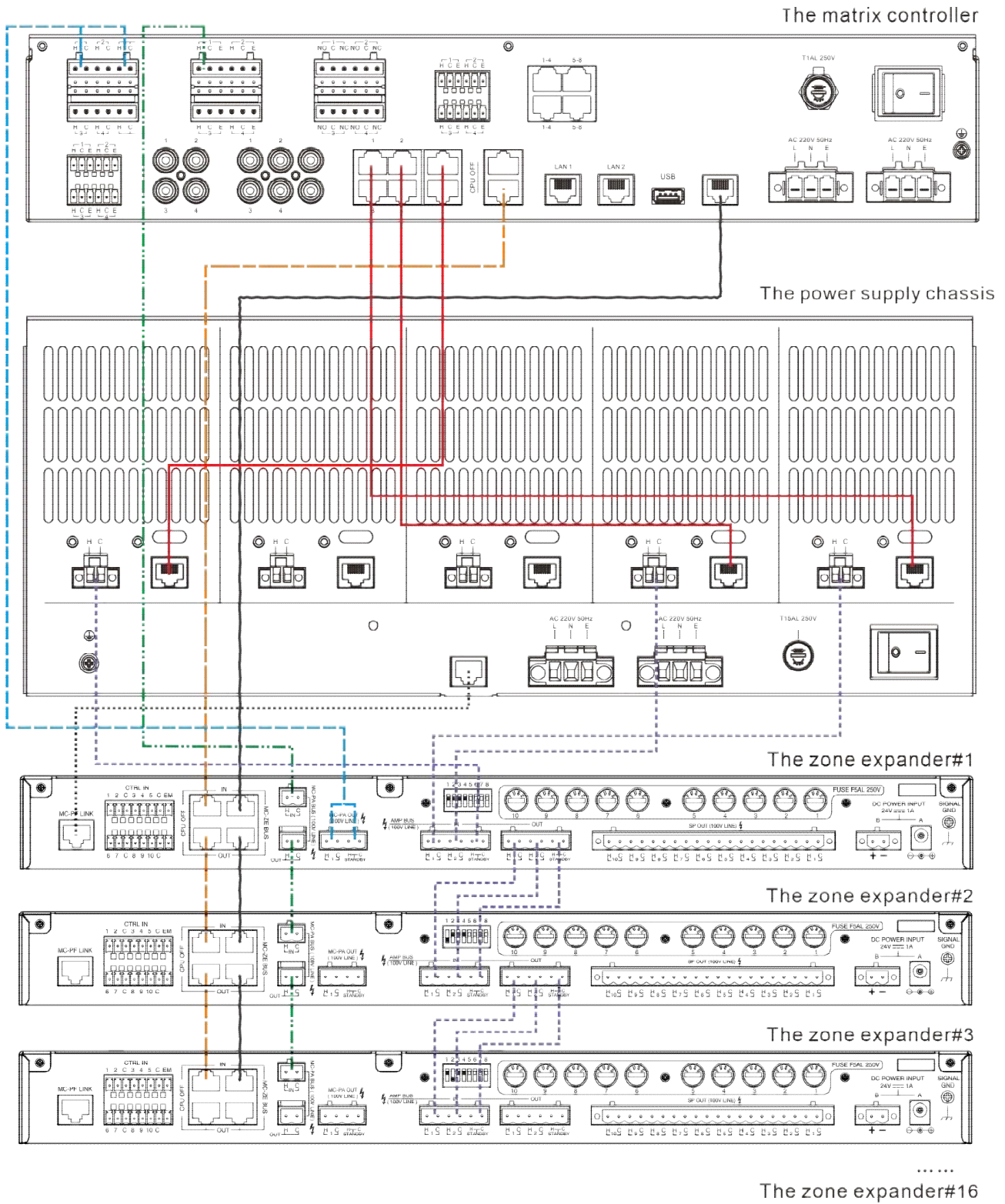

3.1.2 Single-channel wiring diagram (Connect to 1 power amplifier)

Example of 3 VX-1010ZE, 30 speaker-out lines

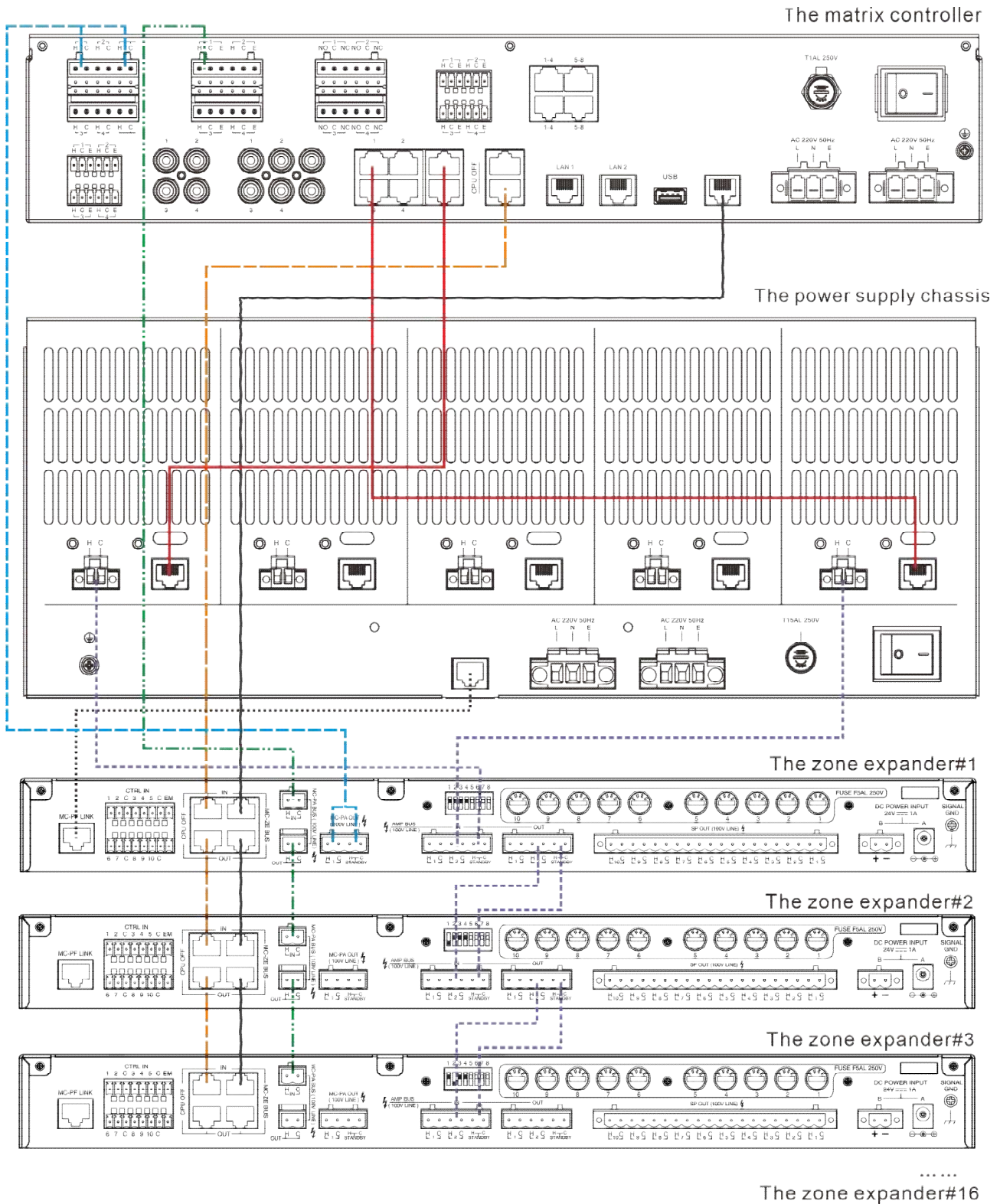

3.1.3 Example of Audio Signal Paths of VX-1000MC, VX-1000PF and VX-1010ZE

- ▶ Audio source signal: The VX-1000MC outputs to the power amplifier
- - -▶ Power amplifier output: Amplifier output to VX-1010ZE
- - -▶ Power amplifier feedback input signal: Detect whether the signal input into the VX-1000MC or not.
- - -▶ Power amplifier feedback output signal: The VX-1000MC outputs the surveillance signal to the VX-1010ZE.

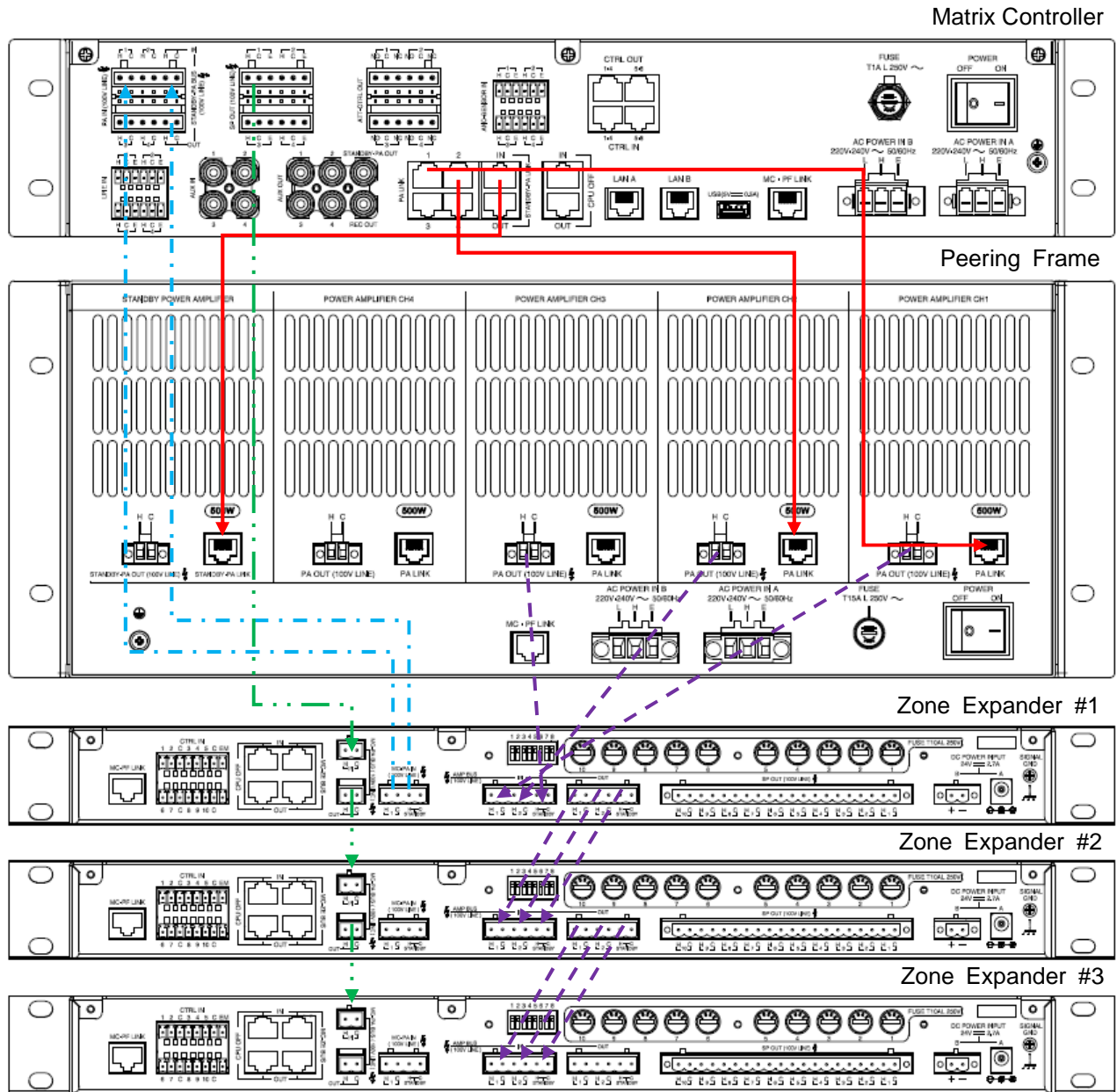

3.1.4 Audio signal path in different status

In Normal case:

- <MC-CH1> → <PF-CH1> → <ZE#1+#2+#3-AMP BUS> speaker (Channel controlled by software)
- <MC-CH2> → <PF-CH2> → <ZE#1+#2+#3-AMP BUS> speaker (Channel controlled by software)

In case of Amplifier fault (Standby amplifier enabled):

- <MC-STBY> → <PF-STBY> → <ZE#1+#2+#3-AMP BUS> speaker (channel controlled by software)
- <MC-CH2> → <PF-CH2> → <ZE#1+#2+#3-AMP BUS> speaker (channel controlled by software)

In case that Matrix Controller is in Surveillance Mode:

- <MC-CH1> → <PF-CH1> → <ZE--MC--PA IN> → <MC--AMP IN1>
- <MC-SP OUT-CH1> → <ZE--MC--PA BUS>speaker (All channel)

3.2 Dimension (Unit : mm)

493

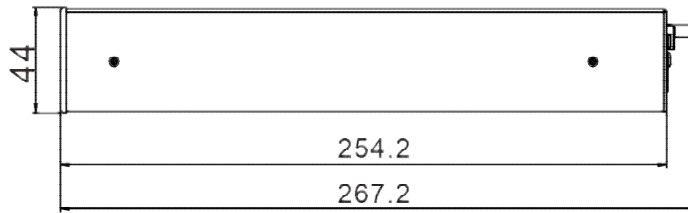
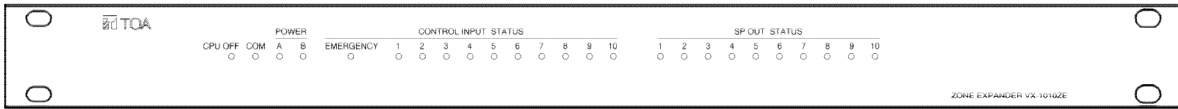
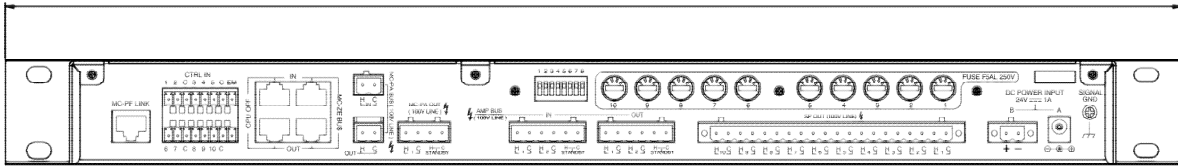

4 APPENDIX

4.1 Specification

4.1.1 VX-1010ZE Zone Exander

Model	VX-1010ZE
power supply	DC Power Input A: DC24V/1A, DC Jack (for AC adapter) DC Power Input B: DC24V/1A, Terminal Block
Standby Power Consumption	≤5W
Control Input (CTRL IN)	10channels + Emergency, Terminal block (8P * 2)
CPU OFF	RJ45 * 2 (Cascade connection)
MC-ZE BUS	RJ45 * 2 (Cascade connection)
MC-PF LINK	RJ45 * 1
Surveillance Tone BUS (MC-PA BUS)	1 channel, Terminal Block 2P * 2 (Cascade connection)
Amplifier Signal feedback (MC-PA OUT)	1 channel + STANDBY, Terminal Block 4P * 1
Amplifier Connection BUS (AMP BUS)	3 channels (CH1, CH2 and STANDBY), Terminal Block 6P * 2
Speaker Line Output (SP OUT)	10 channels, Terminal Block 20P * 1
DIP Switch	8-bit DIP Switch, the first four (1,2,3,4) are ZE's ID number, the last four (4,5,6,8) are reserved
LED	CONTROL INPUT * 10 (Green) SP OUT * 10 (Green, Red, Orange) EMERGENCY * 1 (Red) POWER * 2 (Green) CPU OFF * 1 (Red) COM * 1 (Green)
Operating Temperature	0°C~+40°C
Operating humidity	≤90%, no condensation
Material	Panel: Aluminum profile surface oxidation treatment, black
Size	493(W) × 44(H) × 254.2(D) mm
Weight	3.38 kg
Accessories	AC adapter (DC24V/1A, EU plug) * 1; AC adapter (DC24V/1A, UK plug) * 1; Fuse (5A) * 10; Terminal Block 4P * 1 (for MC-PA OUT); Terminal Block 8P * 2 (for CTRL IN); Terminal Block 2P (with screw) * 1 (for DC Power Input B); Terminal Block 2P * 2 (for MC-PA BUS); Terminal Block 6P * 2 (for AMP BUS); Terminal Block 20P (with screw) * 1 (for SP OUT);

Traceability Information for Europe

Manufacturer:

TOA Corporation

7-2-1, Minatojima-Nakamachi, Chuo-ku, Kobe, Hyogo, Japan

Authorized representative:

TOA Electronics Europe GmbH

Suederstrasse 282, 20537 Hamburg, Germany

URL: <https://toa.com.sg/>