



INSTRUCTION MANUAL

**MATRIX CONTROLLER
PEERING FRAME**

**POWER AMPLIFIER MODULE 250W
 500W**

**VX-1000MC
VX-1000PF
VX-1250DA
VX-1500DA**

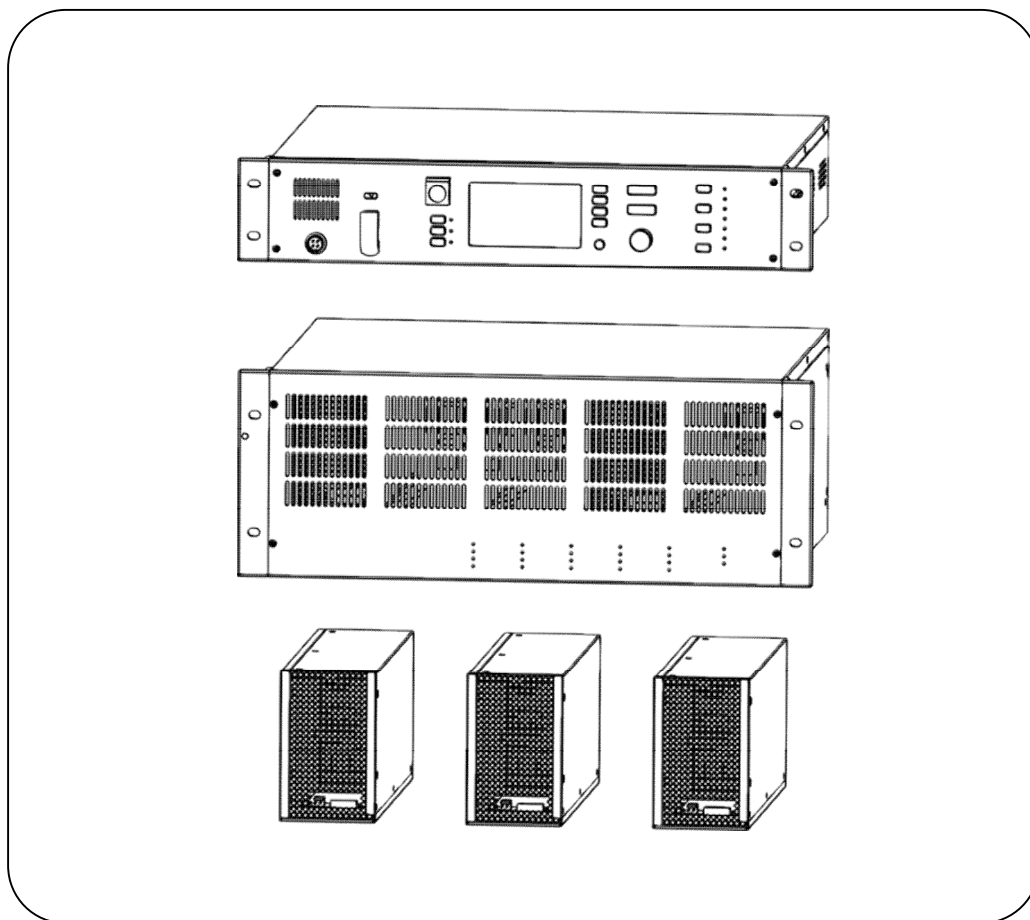

Thank you very much for purchasing TOA VX-1000 series product.
Please read the instructions in this manual carefully, to ensure long-term, trouble-free operation of the system.

TABLE OF CONTENTS

TABLE OF CONTENTS	2
1 SAFETY PRECAUTIONS	3
2 PRODUCT INTRODUCTION.....	5
2.1 Overview	5
2.2 Interface Description	6
3 WIRING.....	12
3.1 VX-1000MC Matrix Controller Wiring Diagram	12
3.2 VX-1500DA/VX-1250DA Power Amplifier Module Installation Diagram	13
3.3 Reference Size (unit : mm)	14
4 INSTRUCTIONS.....	15
4.1 WEB Page Parameters Configure	15
4.2 VX-1000 Configuration tool operating instructions.....	21
4.3 Initiate broadcast.....	31
4.4 Monitoring.....	34
4.5 System menu	35
5 TROUBLESHOOTING	36
5.1 Troubleshooting	36
6 APPENDIX	39
6.1 Specification	39

1 SAFETY PRECAUTIONS

- Before installation or use, be sure to carefully read all the instructions in this section for correct and safe operation.
- Be sure to follow all the precautionary instructions in this section, which contain important warnings and/or cautions regarding safety.
- After reading, keep this manual handy for future reference.

Safety Symbol and Message Conventions

Safety symbols and messages described below are used in this manual to prevent bodily injury and property damage which could result from mishandling. Before operating your product, read this manual first and understand the safety symbols and messages so you are thoroughly aware of the potential safety hazards.



WARNING

Indicates a potentially hazardous situation which, if mishandled, could result in death or serious personal injury.

When Installing the Unit

- Do not expose the unit to rain or an environment where it may be splashed by water or other liquids, as doing so may result in fire or electric shock.
- Use the unit only with the voltage specified on the unit. Using a voltage higher than that which is specified may result in fire or electric shock.
- Do not cut, kink, otherwise damage nor modify the power supply cord. In addition, avoid using the power cord in close proximity to heaters, and never place heavy objects -- including the unit itself -- on the power cord, as doing so may result in fire or electric shock.
- Be sure to ground to the safety ground (earth) terminal to avoid electric shock. Never ground to a gas pipe as a catastrophic disaster may result.

When the Unit is in Use

- Should the following irregularity be found during use, immediately switch off the power, disconnect the power supply plug from the AC outlet and contact your nearest TOA dealer. Make no further attempt to operate the unit in this condition as this may cause fire or electric shock.
 - If you detect smoke or a strange smell coming from the unit
 - If water or any metallic object gets into the unit
 - If the unit falls, or the unit case breaks
 - If the power supply cord is damaged (exposure of the core, disconnection, etc.)
 - If it is malfunctioning (no tone sounds)
- To prevent a fire or electric shock, never open nor remove the unit case as there are high voltage components inside the unit. Refer all servicing to qualified service personnel.
- Do not place cups, bowls, or other containers of liquid or metallic objects on top of the unit. If they accidentally spill into the unit, this may cause a fire or electric shock.
- Do not insert nor drop metallic objects or flammable materials in the ventilation slots of the unit's cover, as this may result in fire or electric shock.
- Do not touch a plug during thunder and lightning, as this may result in electric shock.
- When replacing the fuse, be sure to use the supplied one. Using any other fuse than supplied may cause fire or electric shock.



CAUTION

Indicates a potentially hazardous situation which, if mishandled, could result in moderate or minor personal injury, and/or property damage.

When Installing the Unit

- Never plug in nor remove the power supply plug with wet hands, as doing so may cause electric shock.
- When unplugging the power supply cord, be sure to grasp the power supply plug; never pull on the cord itself. Operating the unit with a damaged power supply cord may cause a fire or electric shock.
- When moving the unit, be sure to remove its power supply cord from the wall outlet. Moving the unit with the power cord connected to the outlet may cause damage to the power cord, resulting in fire or electric shock. When removing the power cord, be sure to hold its plug to pull.

- Do not block the ventilation slots in the unit's cover. Doing so may cause heat to build up inside the unit and result in fire. Also, periodically clean the ventilation slots of dust.
- Avoid installing the unit in humid or dusty locations, in locations exposed to the direct sunlight, near the heaters, or in locations generating sooty smoke or steam as doing otherwise may result in fire or electric shock.
- To avoid electric shocks, be sure to switch off the unit's power when connecting speakers.
- Be sure to follow the instructions below when rack-mounting the unit. Failure to do so may cause a fire or personal injury.
- Install the equipment rack on a stable, hard floor. Fix it with anchor bolts or take other arrangements to prevent it from falling down.
- When connecting the unit's power cord to an AC outlet, use the AC outlet with current capacity allowable to the unit.
- Rack-mounting screws are not supplied with the unit. Prepare them that are appropriate for the equipment rack.

When the Unit is in Use

- Make sure that the volume control is set to minimum position before power is switched on. Loud noise produced at high volume when power is switched on can impair hearing.
- Do not operate the unit for an extended period of time with the sound distorting. Doing so may cause the connected speakers to heat, resulting in a fire.
- Contact your TOA dealer as to the cleaning. If dust is allowed to accumulate in the unit over a long period of time, a fire or damage to the unit may result.
- If dust accumulates on the power supply plug or in the wall AC outlet, a fire may result. Clean it periodically. In addition, insert the plug in the wall outlet securely.
- Switch off the power, and unplug the power supply plug from the AC outlet for safety purposes when cleaning or leaving the unit unused for 10 days or more. Doing otherwise may cause a fire or electric shock.

2 PRODUCT INTRODUCTION

2.1 Overview

Matrix controller (VX-1000MC) can broadcast general paging and emergency broadcasting linked with fire alarm system. This system is suitable for middle size of the buildings such as factories, schools, hospitals, shopping malls etc., as Public Address system and Emergency broadcasting system.

VX-1000MC Matrix Controller:

- (1) Standard 2U rack-mounted design, 4.3-inch true color LCD screen, which can display information such as working status and equipment parameters.
- (2) Support Emergency broadcast function, can receive alarm signal from the fire alarm system.
- (3) Support local broadcast, network broadcast, schedule broadcast, etc.; can realize multi-receiver and multi-source broadcast, schedule broadcast, control input trigger source broadcast and other functions.
- (4) Support zone control, you can manually select the audio source and zones, support the control of local audio input playback to any audio output, and can play any audio source in any zones.
- (5) Optional Paging microphone can be used for general paging broadcasting and emergency broadcasting.
- (6) Built-in monitor speakers, which can monitor the audio source in speaker zone.
- (7) With ANC (Ambient Noise Controller) function, it can monitor the ambient noise of each output channel in real time, automatically adjust the output sound volume, and improve the clarity of the sound.
- (8) With self-check function, the self-check is realized through the "self-check" key on the front panel. During the self-check process, all the LEDs on the front panel are always on (true color LCD screen alternately display different colors), and the fault indication buzzer sounds continuously. During the self-check process, all devices directly connected to the matrix controller execute the self-check function.
- (9) With fault detection function, it can detect the open circuit, short circuit, ground fault, power amplifier fault and power supply fault of the loudspeaker circuit.
- (10) It has the function of the change-over to standby-amplifier. When one power amplifier failure is detected, it can be automatically switch to the standby-amplifier to continue the broadcasting without stopping the system.
- (11) Equipped with dual network ports, supporting network redundancy backup, one network interruption, can automatically switch to another network.
- (12) With CPU OFF function, when the device has problem or the network is paralyzed, the CPU OFF function can be turned on to realize the whole area broadcasting.
- (13) Support redundancy for power supply, usually from power supply A, when the power supply A fails, it can automatically switch to the power supply B; when the power supply A returns to normal, it will automatically return to the power supply A.

VX-1000PF Peering Frame:

- (1) The standard 4U rack design is used to supply power to the power amplifier module inserted into Peering Frame.
 - (2) Provide 4 channels power amplifier slot + 1 channel standby power amplifier slot.
 - (3) The operation and fault status of the power amplifier module can be displayed.
 - (4) It can show whether the standby power amplifier is in working or not.
- Support redundancy for power supply, usually from the power supply A, when the power supply A fails, it can automatically switch to the power supply B; when the power supply A returns to normal, it will automatically return to the power supply A.

VX-1500DA/VX-1250DA Power Amplifier Module:

- (1) Class D power amplifier, high efficiency and energy saving.
- (2) There are two power amplifiers (500W and 250W).
- (3) Modular design, small and light appearance.
- (4) It has a fault detection function, which can detect faults such as overcurrent, overheat, and fan abnormality, and displays them on the LED light of the power supply chassis.

2.2 Interface Description

2.2.1 VX-1000MC Matrix Controller

[Front]

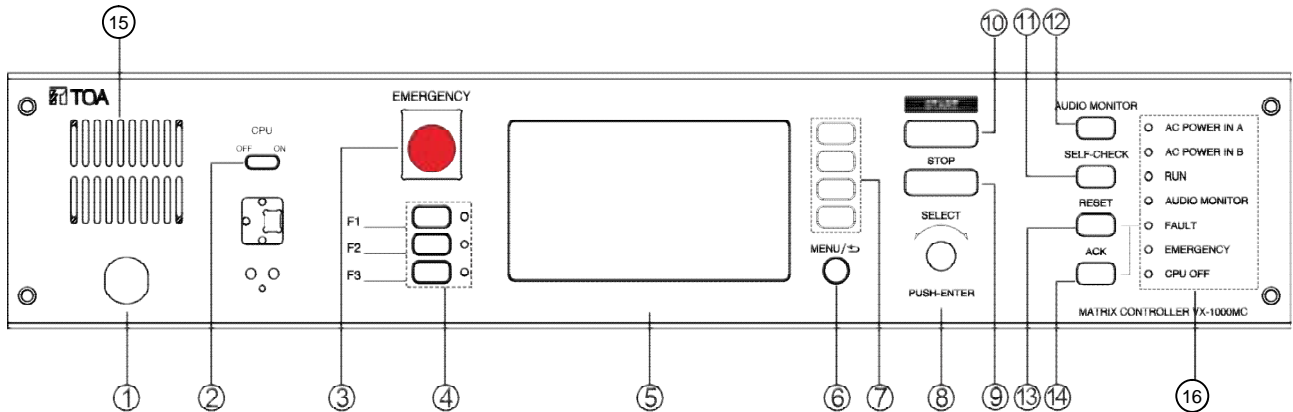

- ① Paging Microphone Interface: Connect the paging microphone (PM-100VX-EA) to this interface, used for general broadcasting and emergency broadcasting.
- ② CPU OFF Key: Switch to the OFF position means that the paging microphone channel is open; switch to the ON position means that the paging microphone channel is closed (Note: when the CPU is down, please manually switch to OFF to enable).
- ③ Emergency Broadcast Key: Press this key to manually initiate emergency broadcast. The key has a protective cover to prevent misuse. When you need to switch to manual emergency mode, first lift the protective cover, then press the key, the key LED lights red.
- ④ Preset Key and status LED: Press the preset key, the preset broadcast task will be executed. (Note: The preset broadcast needs to be configured in the "VX-1000 Setting Software" in advance.)
Preset 1/2/3 status lights: Press the preset key, the corresponding LED lights green; when the preset task ends, the light goes out.
- ⑤ 4.3-inch true color LCD screen: Display device parameters, working status, etc.
- ⑥ Menu / Back Key
- ⑦ Zone Selection Key: Press to select the corresponding zone (multiple selection is supported), press again to cancel the selection.
- ⑧ Operate Key: Rotate the Operate Key to select the menu, and press the Operate Key to confirm the selection.
- ⑨ STOP Key: Press this key to stop broadcasting / monitoring.
- ⑩ START Key: Press this key to start broadcasting / monitoring.
- ⑪ SELF-CHECK Key: Press this key to perform self-check, and press the self-check key again to end the self-check. During the self-check, all the LEDs on the front panel are always on (true color LCD screen alternately display different colors), and the fault indication buzzer continues to sound.
- ⑫ AUDIO MONITOR Key: Press this key to monitor the audio source and zone audio.
- ⑬ RESET Key: When the system has a fault, press the "Reset" key to reset the fault state, the fault LED returns to the normal state, and then re-detect the system fault.
- ⑭ ACK Key: When the system detects a fault, press the "ACK" (ACKnowledge) key to confirm the fault, the fault LED orange light is always on, and the LCD screen displays specific fault information.
- ⑮ Speaker
- ⑯ Equipment status LED, the relevant instructions are as follows:

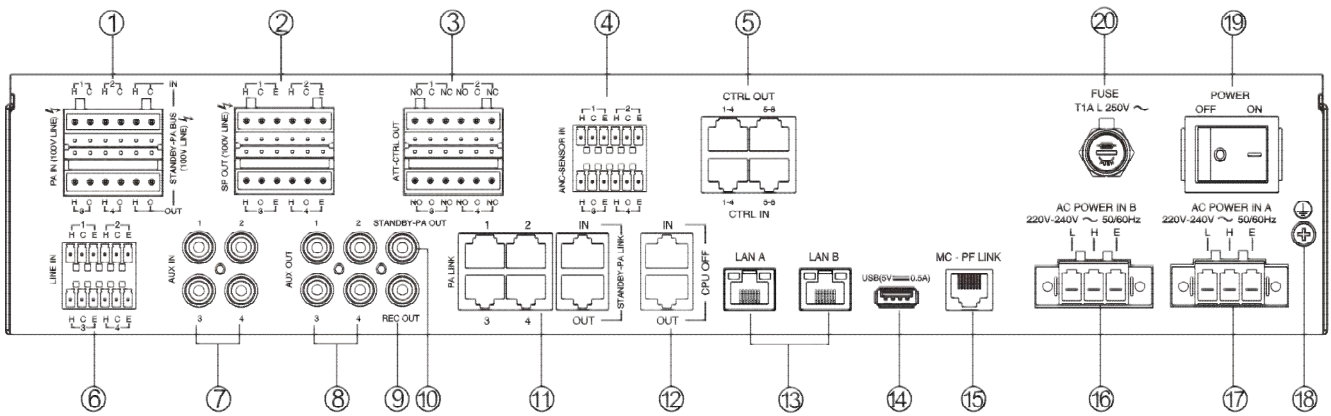

Status LED	Introduction
AC POWER IN A	Two-color lights, orange light without power input, green light with power input.
AC POWER IN B	Two-color lights, In case surveillance function is enable: if there is no power input, lights orange, if there is power input, lights green; In case surveillance function is disable: if there is no power input, no lights, if there is power input, lights green.
RUN	The device is steady green after the device is started and can work normally.
AUDIO MONITOR	Press the AUDIO MONITOR Key to enter the monitor state, the monitor status light is always green; Press the monitor key again to exit the monitor state and the monitor status light goes out.
FAULT	The orange light flashes when the device is faulty; after pressing the confirm key, the orange light is always on. After all the faults are eliminated or the reset key is pressed, the orange light goes out.
EMERGENCY	When the emergency broadcast occurs, the LED lights red; After the emergency broadcast stops, the LED goes off.
CPU OFF	When the "CPU" switch is pulled to the "OFF" state, the CPU OFF LED lights red; When the "CPU" switch is pulled to the "ON" state, the CPU OFF LED goes out.

[Rear]



- ① PA IN: 4 power amplifier inputs + 1 backup power amplifier input, used to connect the 100V amplifier output port of any amplifiers. 1 cascade power amplifier input (used when two matrix controllers are cascaded), used to connect the cascade power amplifier input of another Matrix Controller (VX-1000MC). (H: hot end, C: cold end).
- ② SP OUT: 4 channels of power amplifier signal output, used to connect the speaker line. (H: hot terminal, C: cold terminal, E: ground terminal)
- ③ ATT-CTR OUT: 4 channels attenuator control output. (NO: normally open, C: public, NC: normally closed)
- ④ ANC-SENSOR IN: 4 microphone (as an ambient detection sensor) inputs, which can be connected to an ambient noise detector to automatically adjust the broadcast sound output level according to environmental noise level. (H: hot terminal, C: cold terminal, E: ground terminal)
- ⑤ CTRL IN/ CTRL OUT: 8 control inputs, 8 control outputs. See the next page for the wire sequence and definition of the interface.
- ⑥ LINE IN: 4 channels balanced line signal input, used to connect external audio source equipment. (H: hot terminal, C: cold terminal, E: ground terminal)
- ⑦ AUX IN: 4 channels unbalanced line inputs, used to connect external audio source equipment, such as CD / DVD player, tuner, etc.
- ⑧ AUX OUT: 4 channels unbalanced line outputs, can be connected to active speakers or power amplifier equipment.
- ⑨ REC OUT: 1 channel recording output, used to connect external recording equipment.
- ⑩ STANDBY-PA OUT: 1 channel stand-by audio output interface, can output the audio signal of the stand-by power amplifier channel.
- ⑪ PA LINK: 4 channels power amplifier interface + 1 channel standby power amplifier interface, used to connect the Digital Power Amplifier Unit Built-in Peering Frame (VX-1000PF), to interface 1-4, and standby. 1 channel cascaded power amplifier interface (used when two matrix controllers are cascaded), used to connect the cascaded power amplifier interface of another matrix controller (VX-1000MC). Two matrix controllers cascaded will share a stand-by power amplifier.
- ⑫ CPU OFF: cascade with another matrix controller's CPU OFF interface. (Note: If two devices are cascaded, you must ensure that the CPU OFF cascade interface, cascade power amplifier by PA LINK, and cascade power amplifier interface of the two devices are all connected)
- ⑬ LAN A/ LAN B: dual network ports. When the network cable is not connected, the network interface light is off; after connecting the network cable, the orange light flashes slowly, and the orange light flashes quickly when there is data.
- ⑭ USB: Not used.
- ⑮ MC-PF LINK: Connected to the MC-PF LINK interface of the Peering Frame (VX-1000PF), which can detect the power failure of the Peering Frame.
- ⑯ AC POWER IN B: connect to AC220V-240V standby power supply.
- ⑰ AC POWER IN A: connect to AC220V-240V main power supply.
- ⑱ Ground terminal: connect the ground wire.
- ⑲ POWER Switch: control the power on and off.
- ⑳ FUSE: T1A L / 250V, providing power supply overcurrent protection.

Line sequence and definition of control input / control output interface:

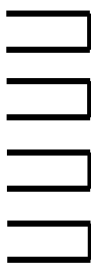
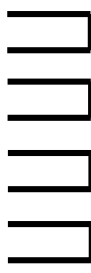
Name	No.	Color	Pair	Pin Assignment	Description
CTRL_OUT 1-4	①	Orange/White		COM 1	Common 1
	②	Orange		NO 1	Normally Open 1
	③	Green/White		COM 2	Common 2
	④	Blue		COM 3	Common 3
	⑤	Blue/White		NO 3	Normally Open 3
	⑥	Green		NO 2	Normally Open 2
	⑦	Brown/White		COM 4	Common 4
	⑧	Brown		NO 4	Normally Open 4
CTRL_OUT 5-8	①	Orange/White		COM 5	Common 5
	②	Orange		NO 5	Normally Open 5
	③	Green/White		COM 6	Common 6
	④	Blue		COM 7	Common 7
	⑤	Blue/White		NO 7	Normally Open 7
	⑥	Green		NO 6	Normally Open 6
	⑦	Brown/White		COM 8	Common 8
	⑧	Brown		NO 8	Normally Open 8
CTRL_IN 1-4	①	Orange/White		CTRL IN 1	Control Input 1
	②	Orange		GND	Ground
	③	Green/White		CTRL IN 2	Control Input 2
	④	Blue		GND	Ground
	⑤	Blue/White		CTRL IN 3	Control Input 3
	⑥	Green		GND	Ground
	⑦	Brown/White		CTRL IN 4	Control Input 4
	⑧	Brown		GND	Ground
CTRL_IN 5-8	①	Orange/White		CTRL IN 5	Control Input 5
	②	Orange		GND	Ground
	③	Green/White		CTRL IN 6	Control Input 6
	④	Blue		GND	Ground
	⑤	Blue/White		CTRL IN 7	Control Input 7
	⑥	Green		GND	Ground
	⑦	Brown/White		CTRL IN 8	Control Input 8
	⑧	Brown		GND	Ground

2.2.2 VX-1000PF Peering Frame

[Front]

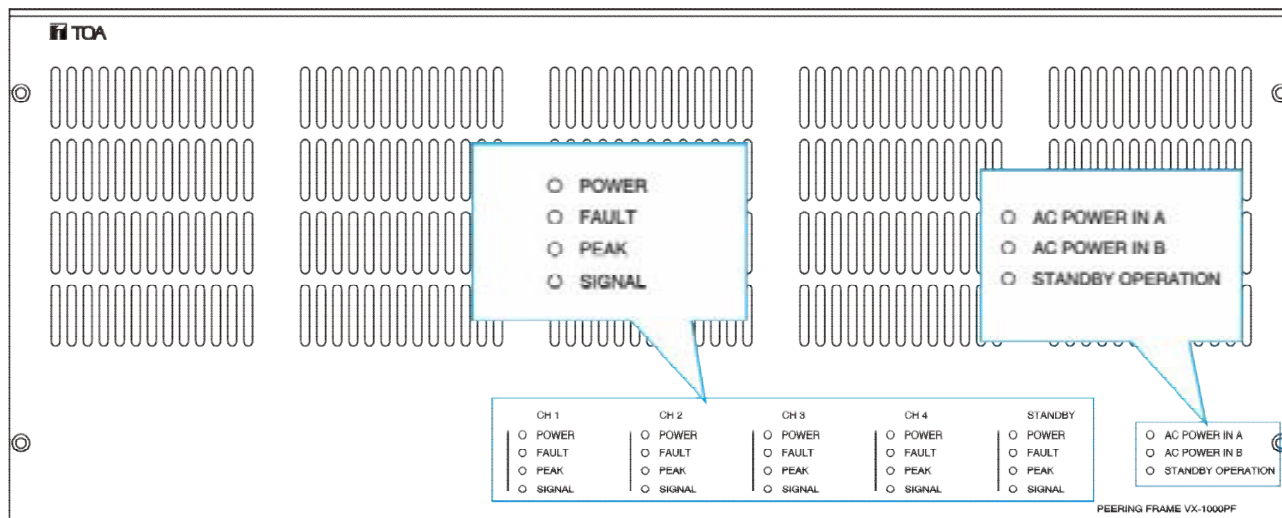

Name	LED light status
AC POWER IN A	Green light when there is power input, and does not light up when there is no power input.
AC POWER IN B	Green light when there is power input, and does not light up when there is no power input.
STANDBY OPERATION	Green light when switching to the standby power amplifier, and the light is off when not switching.
POWER	Green light when the power amplifier channel has power input; without power input, it does not light.
FAULT	If the power amplifier is faulty, it will light orange; if there is no fault, it will not light.
PEAK	When the input signal of the power amplifier reaches the peak value, it lights up in red; if it does not reach, it does not light up.
SIGNAL	The amplifier has an input signal and lights green; no signal, it does not light.

[Rear]

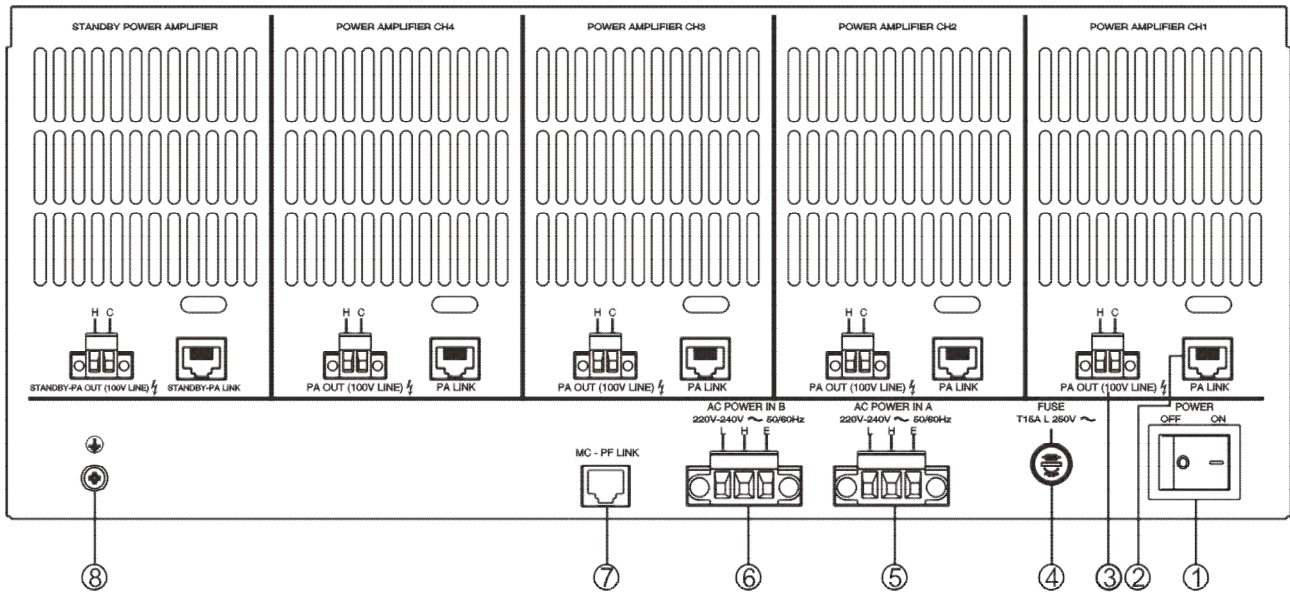

- ① POWER Switch: control the power on and off.
- ② PA LINK: power amplifier interfaces (amplifier channels 1-4), respectively connected to the matrix controller's power amplifier interface 1-4; 1 channel for standby power amplifier interface, connected to the matrix controller's standby power amplifier STANDBY-PA LINK interface.
- ③ PA OUT: power amplifier output (power amplifier channels 1-4), respectively connected to the matrix controller PA IN interface 1-4; 1 channel for standby power amplifier interface, connected to the matrix controller standby power amplifier PA IN interface.
- ④ FUSE: T15AL / 250V, providing power overcurrent protection.
- ⑤ AC POWER IN A: connect to AC220V – 240V power supply.
- ⑥ AC POWER IN B: connect to AC220V – 240V power supply.
- ⑦ MC-PF LINK: Connected to the MC-PF LINK interface of the Matrix Controller (VX-1000MC), it can detect the power failure of the Peering Frame (VX-1000PF).
- ⑧ Ground: connect the ground wire.

3 WIRING

3.1 VX-1000MC Matrix Controller Wiring Diagram

Connect the power output of the peering frame 1-4 respectively, standby

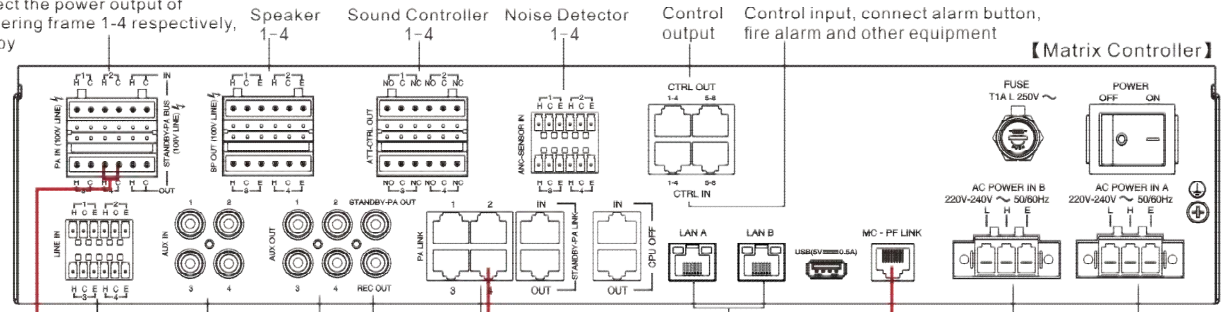

Audio input devices such as CD/DVD players and tuners

Active speaker or amplifier

Recording equipment

Connect the power amplifier interfaces 1-4 of the peering frame respectively, standby

Ethernet switch

AC power in B

AC power in A

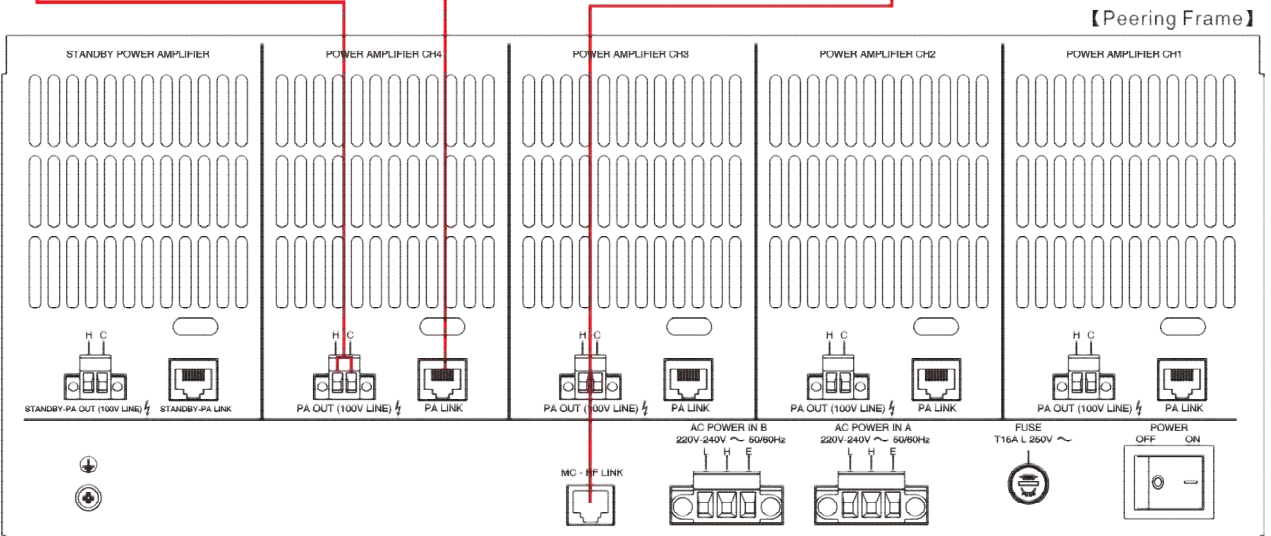

3.2 VX-1500DA/VX-1250DA Power Amplifier Module Installation Diagram

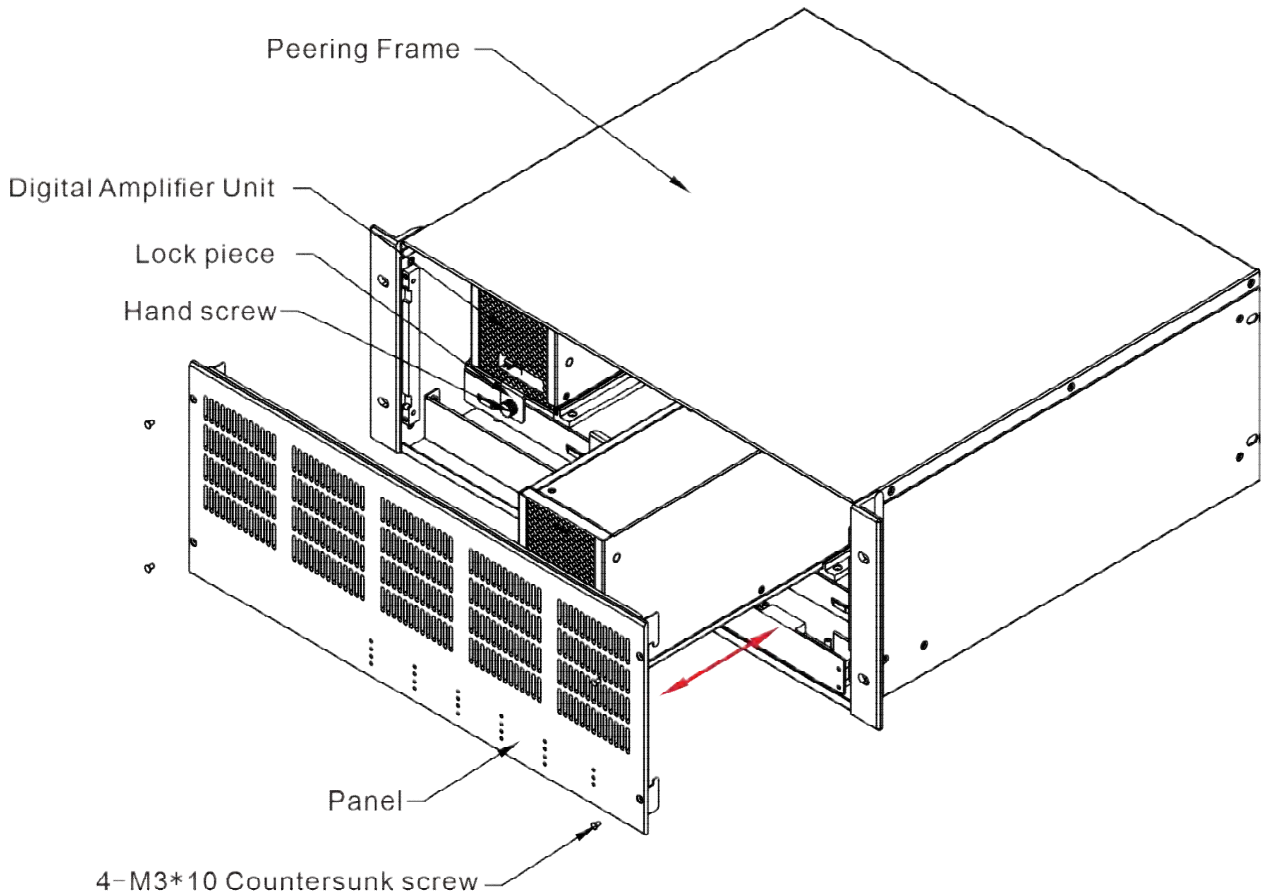

Installation steps

Step 1 : Remove the four M3 * 10 countersunk screws on the panel of the Peering Frame, and then remove the panel.

Step 2 : Loosen the thumb screw (no need to completely unscrew it, the lock piece can be dropped to the lower right), and turn the lock piece to the lower right (hook down).

Step 3 : Push the digital amplifier unit into the corresponding position.

Step 4 : Turn the locking plate to the upper left, with the hook position facing up, hook the hook position on the bottom of the digital amplifier unit, and then tighten the hand screw.

Step 5 : Connect the cable and use 4 M3 * 10 countersunk screws to assemble the panel.

3.3 Reference Size (unit : mm)

3.3.1 VX-1000MC Matrix Controller

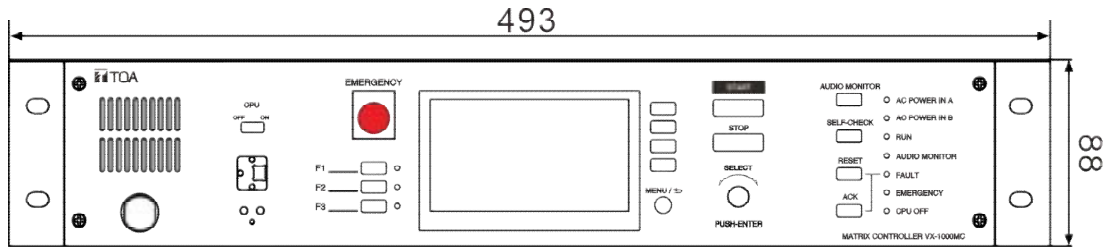

Front view

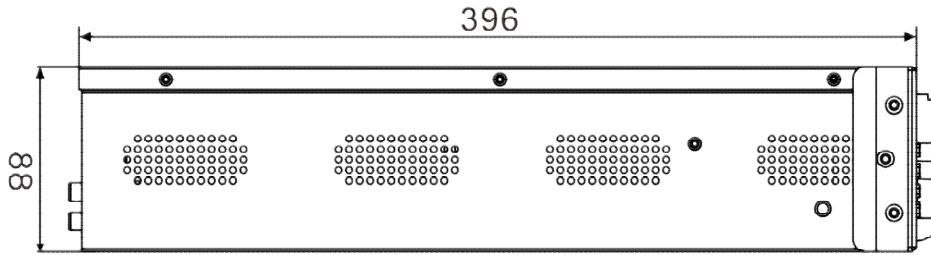

Side view

3.3.2 VX-1000PF Peering Frame

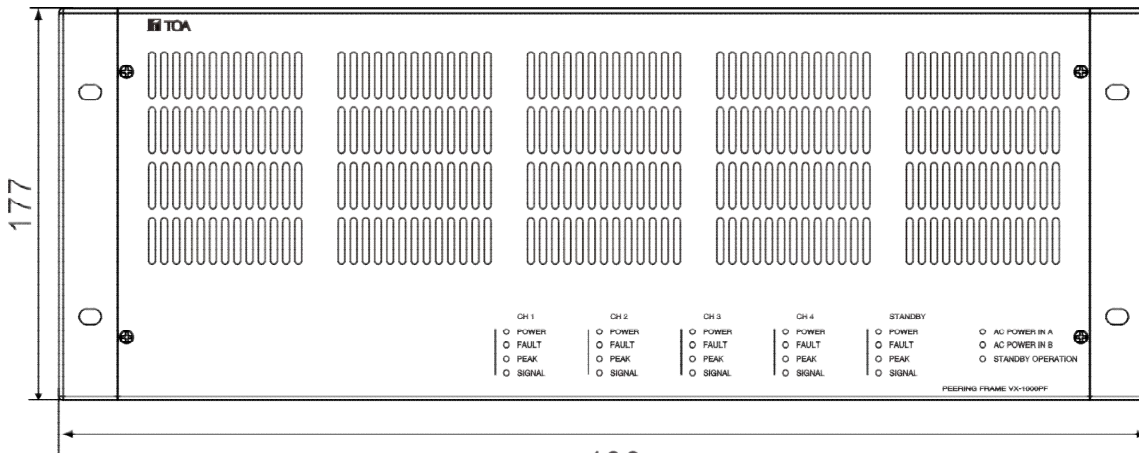

493
Front view

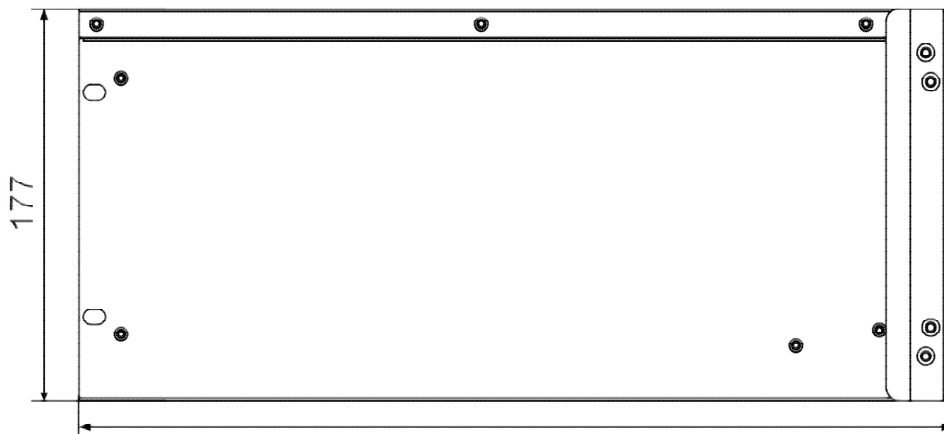

Side view

4 INSTRUCTIONS

4.1 WEB Page Parameters Configure

4.1.1 Web Interface Login

- (1) Enter the IP address (Factory Default IP is 192.168.1.101) of the Matrix Controller (VX-1000MC) in the browser address bar, then press the Enter key.

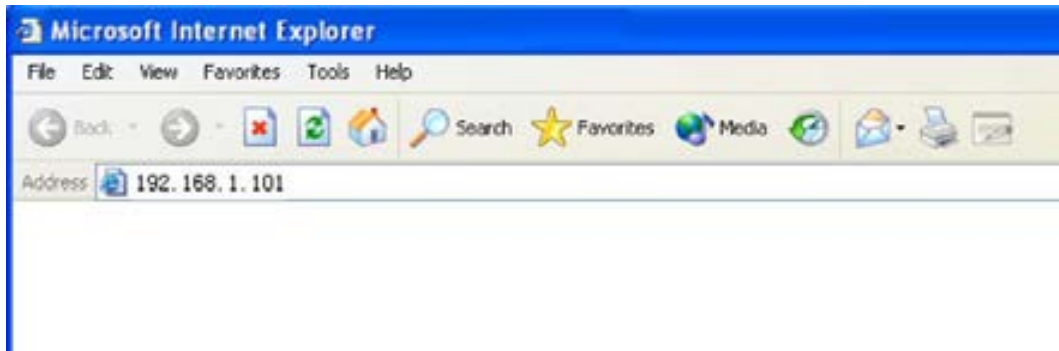

- (2) Enter the user name and password (Defaults are both "admin") in the login window of the Web interface.



- (3) Press "Login", then enter the Web interface of the IP network digital amplifier. (Remark: Please clear caches then set up again if former saved parameters don't take effect in the web page.)

4.1.2 Status

In this web page, users can check terminal ID, terminal IP address, subnet mask, etc. At same time they can check terminal status, real-time value of loudspeaker circuit, real-time value of noise, system date etc.

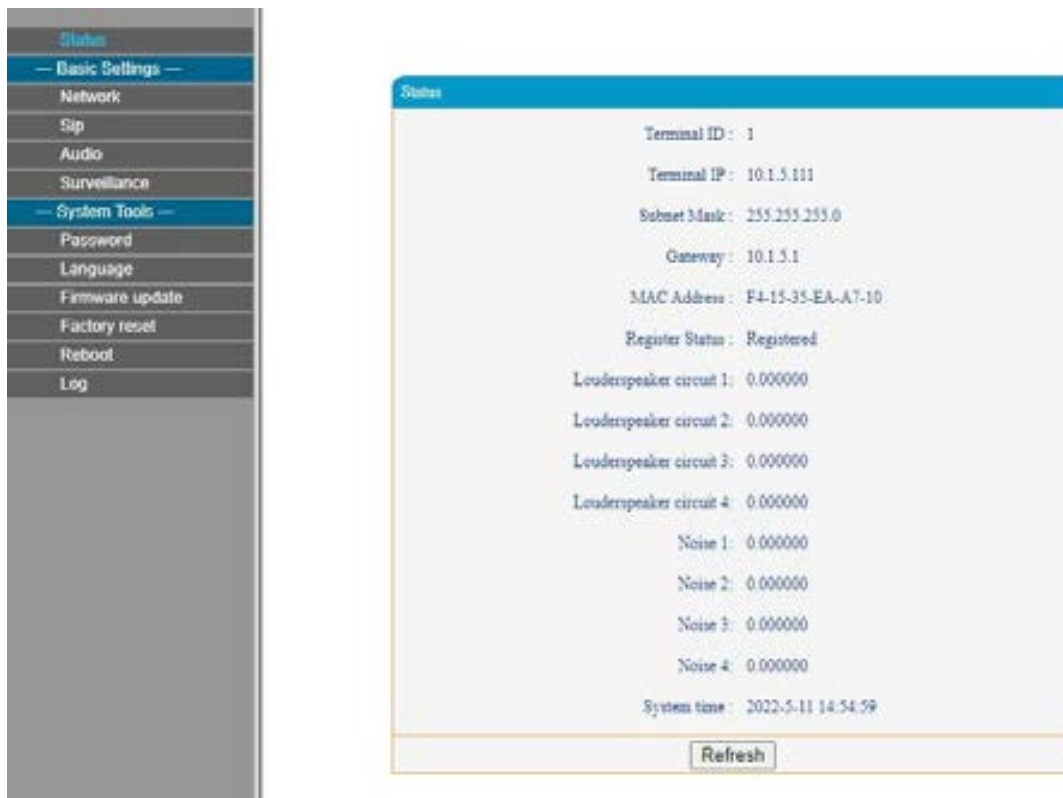

4.1.3 Network Parameters

Set the network parameters, please modify the parameters according to the live environment, save setting, and restart the device to take effect.

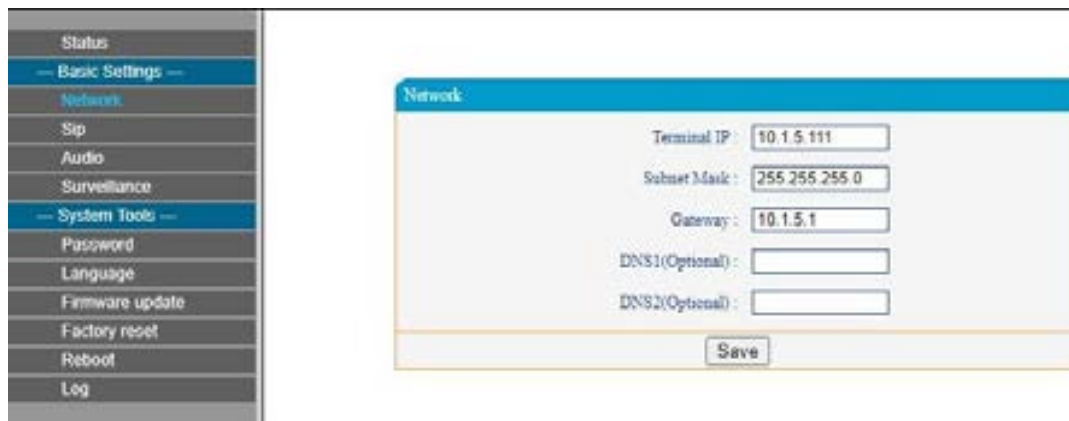

Meanings of the parameters:

Terminal IP	The IP address of the terminal, factory default IP is 192.168.1.101, it cannot be the same as other terminals.
Subnet Mask	Subnet Mask of the device.
Default Gateway	The gateway of the network of the device.
DNS1	The IP of the primary DNS of the network of the device.
DNS2	IP of the secondary DNS of the network of the device.

4.1.4 Sip (SIP protocol)

Set server platform parameters for terminal login. Save after setting, restart the device to take effect.



SIP parameter configuration as per the following,

SIP server	SIP server IP address of the terminal, please input right SIP server IP address or domain name, do not modify without any special situation (the defaults is 5060).
Account	SIP account of terminal, it cannot repeat with other terminals.
Password	Password of terminal login SIP server, it cannot repeat with other terminals.
Local port	Configure local port according to the real situation
Work pattern	“Sever” working mode or “Without Sever” working mode are available. If “server” working mode is selected, the parameter value is configured on the SIP server that the terminal logs in to. The parameters configured on the VX-1000 configuration tool are invalid. The terminal only receives tasks on the SIP server. If no server is selected, the parameters are configured on the VX-1000 configuration tool.

4.1.5 Audio

Set the terminal audio parameters and save, then restart the device to take effect.

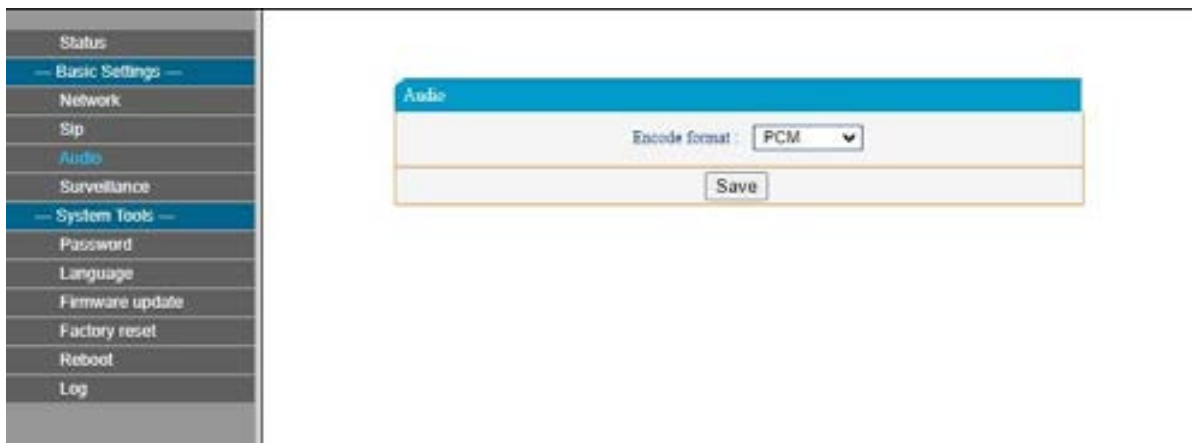

Meanings of the parameters:

Encode format	Set audio encoding format. PCM and AAC are available.
---------------	---

4.1.6 Surveillance

Set the reference horn detection value of the four-way loop according to the real-time value of loop detection in the running state. After the modification is complete, click [Save] and restart the device to take effect. In the process of terminal operation, when the real-time value of loop detection is less than the reference loop horn detection value set, the terminal will report the loop detection fault.

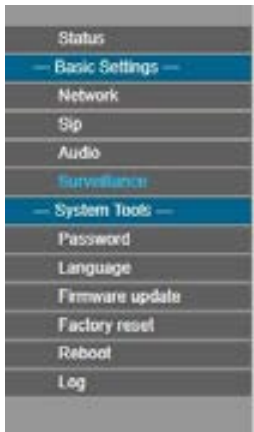
A web form titled 'Surveillance' with a blue header. It contains four input fields labeled 'Speaker line 1:', 'Speaker line 2:', 'Speaker line 3:', and 'Speaker line 4:'. Each field has the number '0' entered. At the bottom right, there is a 'Save' button.

4.1.7 Password

You can modify the account and password in this page. After setting, please restart the web page.

A web form titled 'Password' with a blue header. It contains five input fields: 'Original username:' (with 'admin' entered), 'Original password:', 'New username:', 'New password:', and 'Password Confirm:'. At the bottom, there are 'Save' and 'Clear' buttons.

4.1.8 Language

Language: Set the language of the WEB page. Chinese and English are available.
Timezone: Set the time zone of the terminal.

A web form titled 'Language' with a blue header. It contains two dropdown menus: 'Language:' (set to 'English') and 'Timezone:' (set to '(UTC+08:00)Beijing, Hong Kong'). At the bottom, there is a 'Save' button.

4.1.9 Firmware Upgrade (Note: Do not upgrade the firmware unless there's a special need)

Click the “Select” button, select the firmware upgrade file provided by the manufacturer, then click the “upgrade” button to start upgrade. (Do not power off during the upgrade process, otherwise it may cause the upgrade failure and equipment failure)

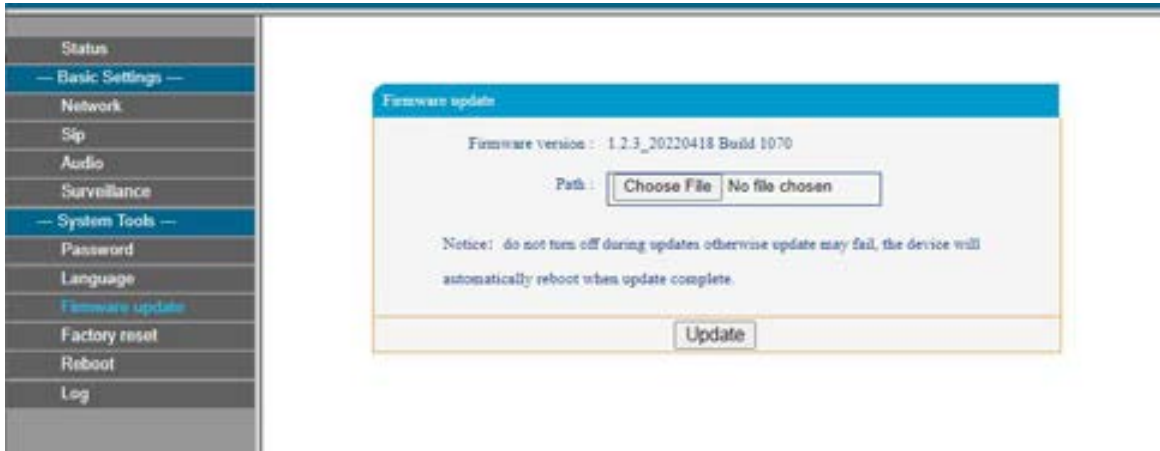

4.1.10 Restore Factory Default Settings

Factory reset: all parameters were restored to factory setting.



4.1.11 Reboot

Click “Reboot” button can manually reboot the device, some of the parameters modification in the Web page will only take effect after rebooting the device.



4.1.12 Log

Matrix Controller can record the operating condition and form log, the user can browser the system log in web page.

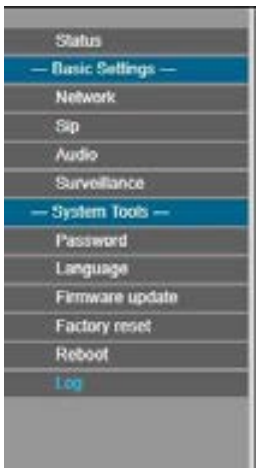

Log	
Index	Content
1	May 11 14:54:56 Login sever 10.1.5.200:5060
1	
<input type="button" value="Refresh"/>	

4.2 VX-1000 Setting Software Operating Instructions

4.2.1 Software Installation

Double-click the "VX-1000 Setting Software" installer and press "Next" to install. After the installation is complete, select "Run as administrator" software.

4.2.2 Basic parameter settings

- (1) **New project file** : Click "File"->"New" in the main interface of the software, enter the project name in the pop-up dialog box, and create a new project file. After the new creation is complete, related settings such as system name and screen display can be made on the "Basic Settings" interface.

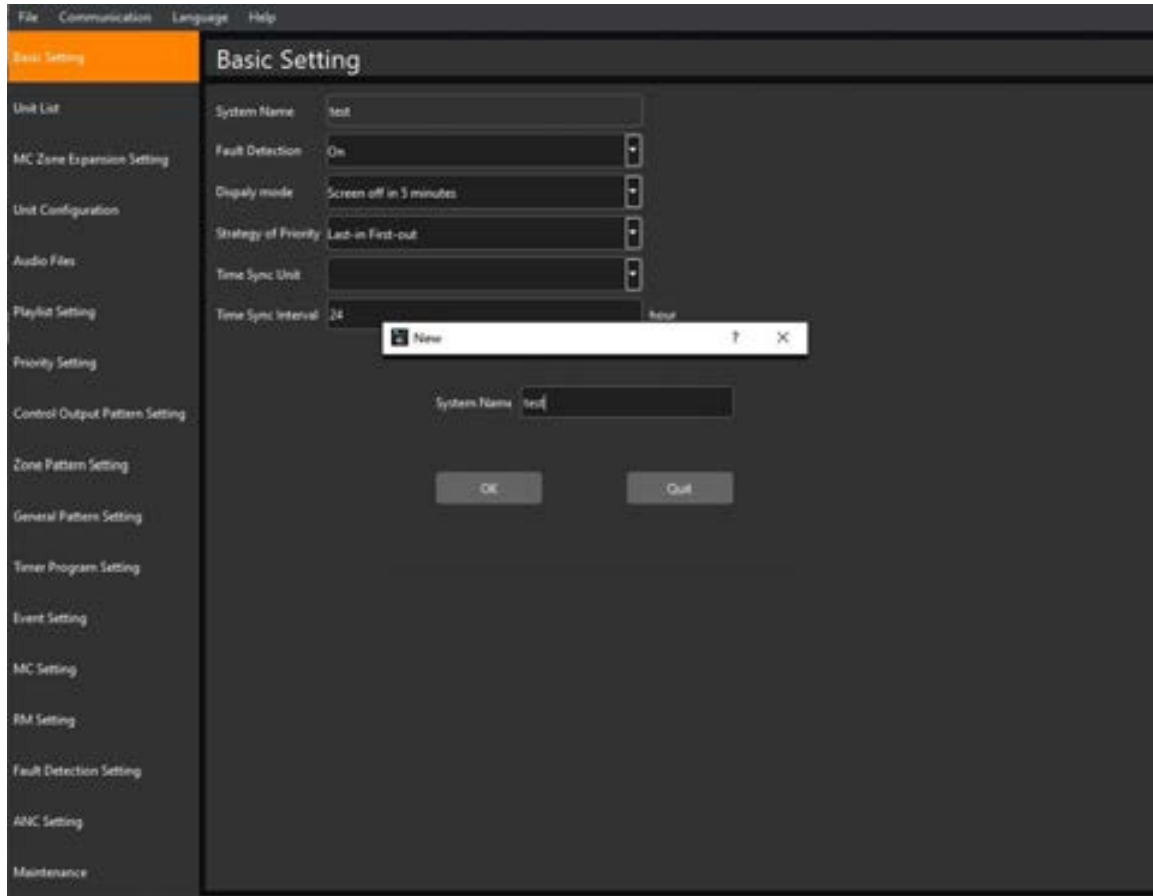

- (2) **Add Unit** : In the "Unit List" interface, add units, set unit's IP and other operations. After the configurations are completed, the system will save configurations automatically.

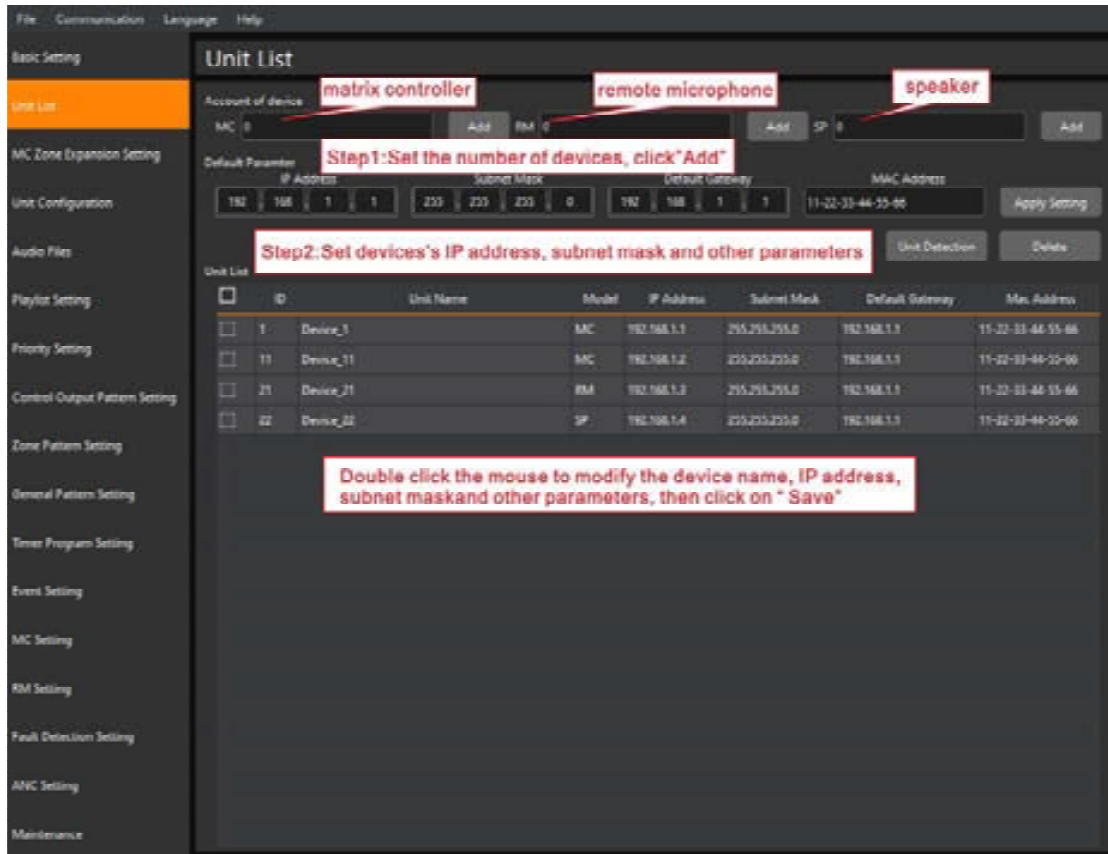

- (3) **Add VX-1010ZE**: Set the number of Zone Expander VX-1010ZE. If the VX-1010ZE is not connected, then you do not need to set this parameter. A maximum of 16 Zone Expander can be added. After the configurations are completed, the system will save configurations automatically.

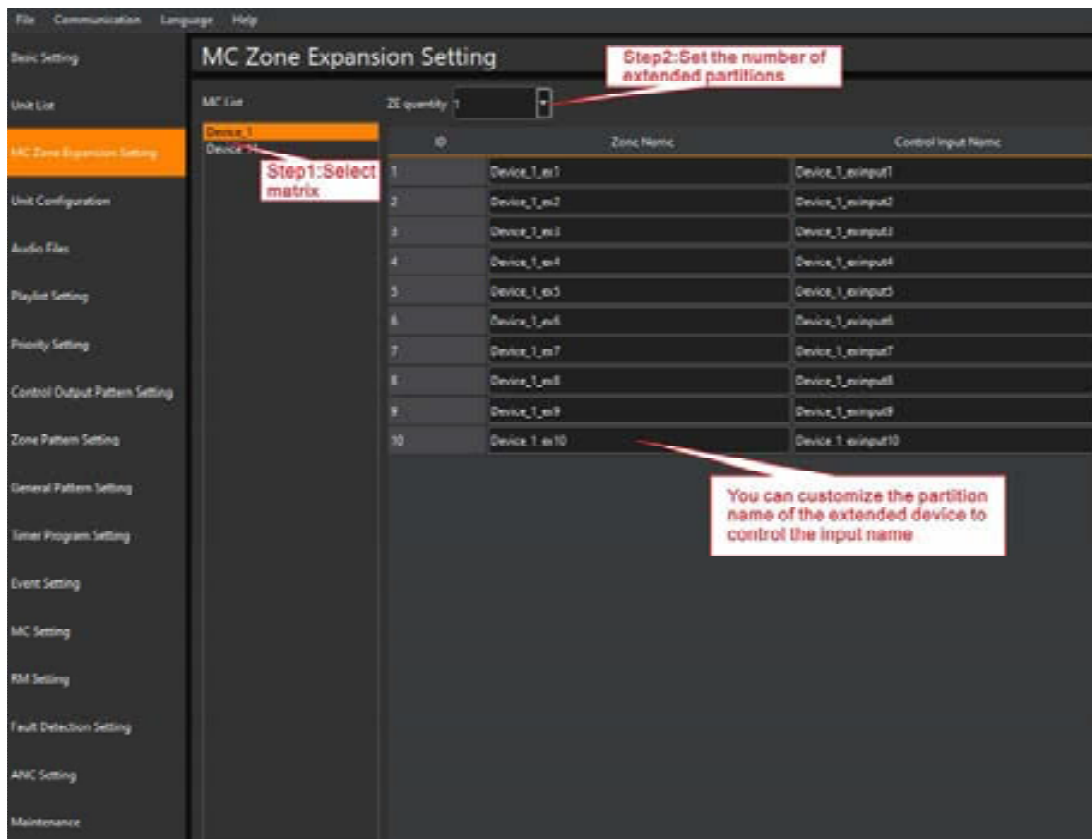

(4) **Unit Configuration** : After units are added, the names of the input and output channels and control input and output channels of each Matrix Controller can be customized in the unit configuration interface. After the configurations are completed, the system will save configurations automatically. The configuration of the Matrix Controller is described as follows:

- i. Select the corresponding Matrix Controller in Unit List. You can customize the input/output channel name, volume, whether to enable the ground detection function, and the name of the control input/output channel for each Matrix Controller. (**Note: Input channels 1-4 respectively correspond to the 4-channel audio source input of the Matrix Controller, and output channels 1-4 respectively correspond to the 4-channel line output of the Matrix Controller. Grounding detection is not enabled when using DA-X power amplifier or such not VX-1000DA units.**)
- ii. If Zone Expander VX-1010ZE are connected, set the channel type in Output Settings. To connect one power amplifier to the Zone Expander, select single channel; to connect two power amplifiers to the Zone Expander, select double channel. A single channel supports only one broadcast output. You can select any channel 1, 2, 3, or 4 as the output channel. Dual channel Supports BGM and two priority broadcasts. You can select 1, 2, or 3, or 4 output channels (1 indicates channels 1 and 2, and 3 indicates channels 3 and 4). BGM broadcasts output from 2 and 4, and priority broadcasts output from 1 and 3.

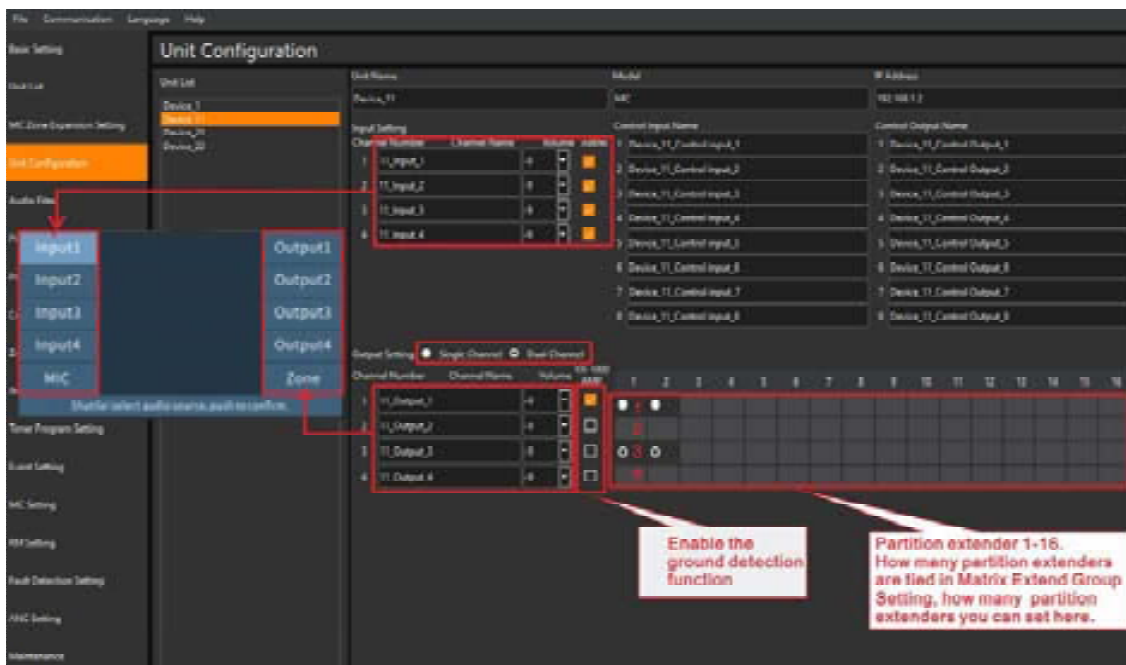

- (5) **Prepare Audio Files** : Click the "Add" button in the "Audio Files" to add audio files (used as a broadcast source). After the configurations are completed, the system will save configurations automatically.



- (6) **Playlist Setting** : Set the broadcast audio file playlist (need to add audio files in the "Audio Files" in advance). After the configurations are completed, the system will save configurations automatically.

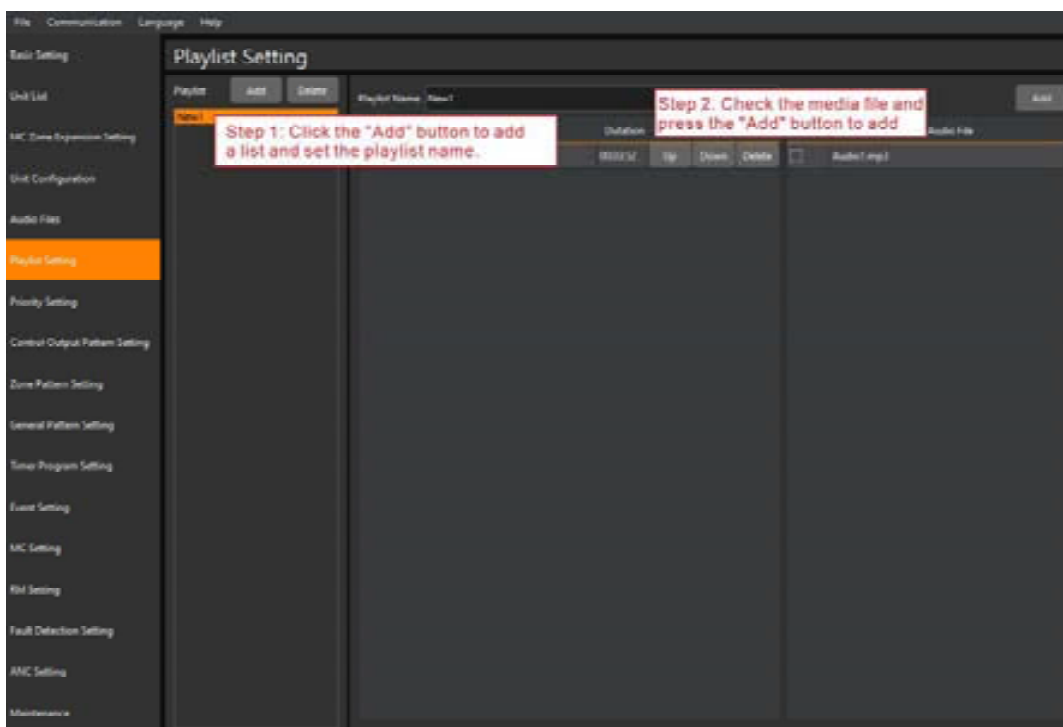

- (7) **Set audio source priority** :Set the audio source type (BGM/General/Emergency) and priority of the unit input channel and playlist. After the configurations are completed, the system will save configurations automatically.



- (8) **Set Control Output Pattern**: On the “Control Output Pattern Setting” interface, multiple control output can be combined to one group.

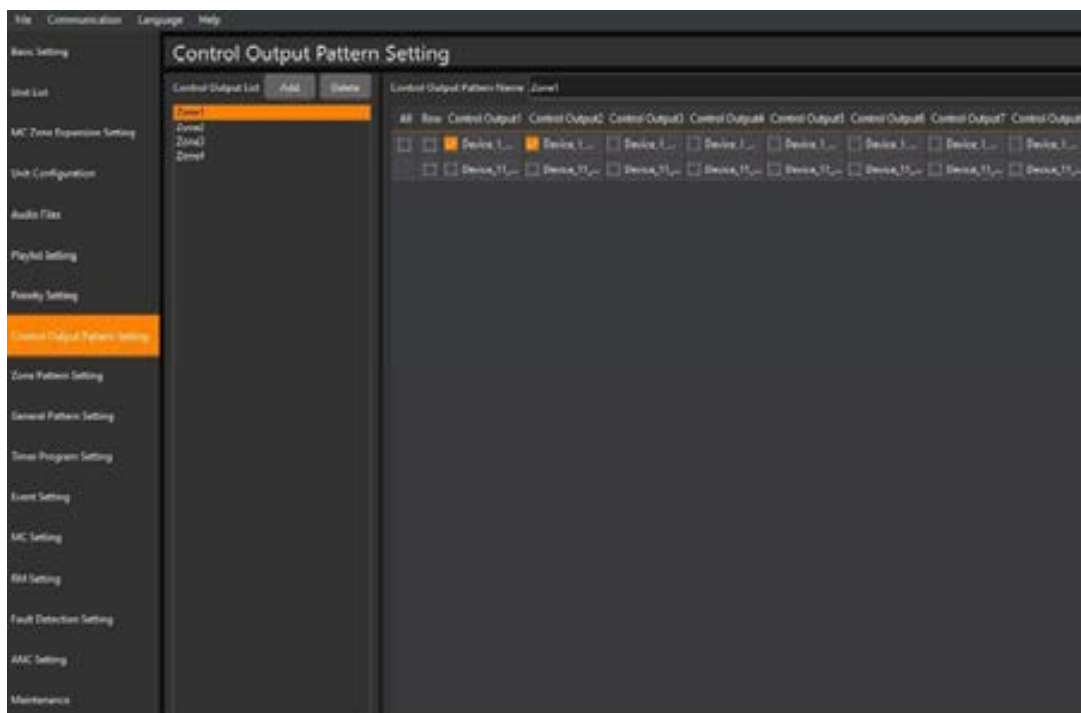

- (9) **Set Zone Pattern** : Enter the “Zone Pattern Setting” interface, create zone patterns which can consist of zones and control outputs. After the configurations are completed, the system will save configurations automatically.

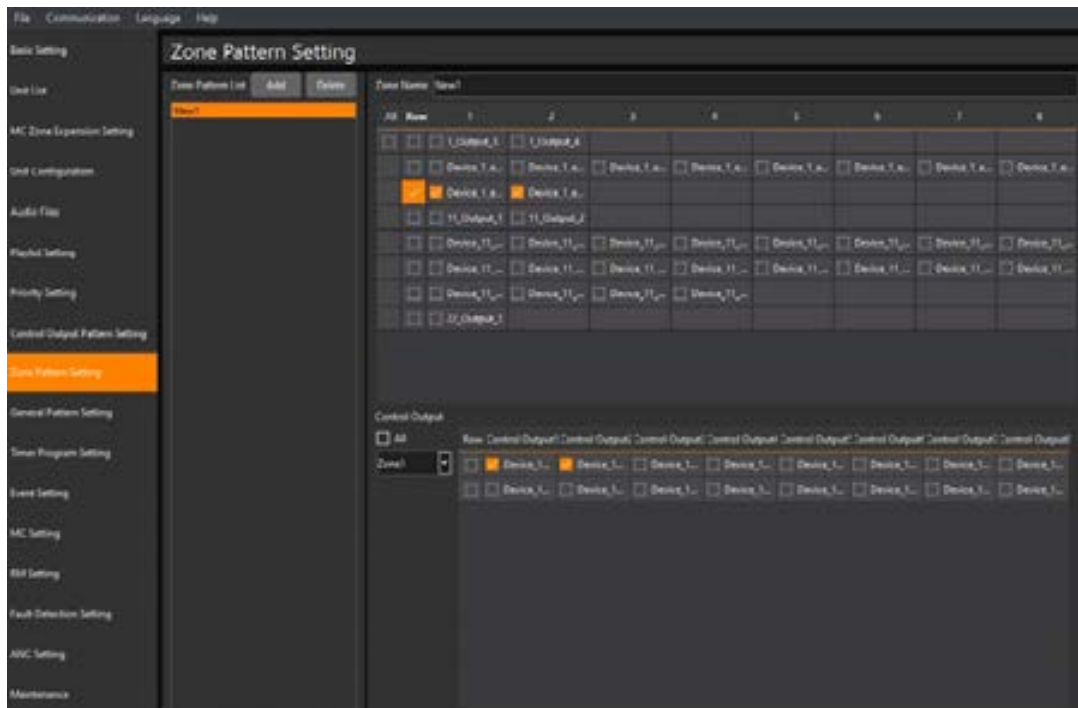

- (10) **Set Broadcast Pattern** : Enter the “General Pattern Setting” interface, create broadcast patterns which consists of audio source, zones and control outputs. After the configurations are completed, the system will save configurations automatically.

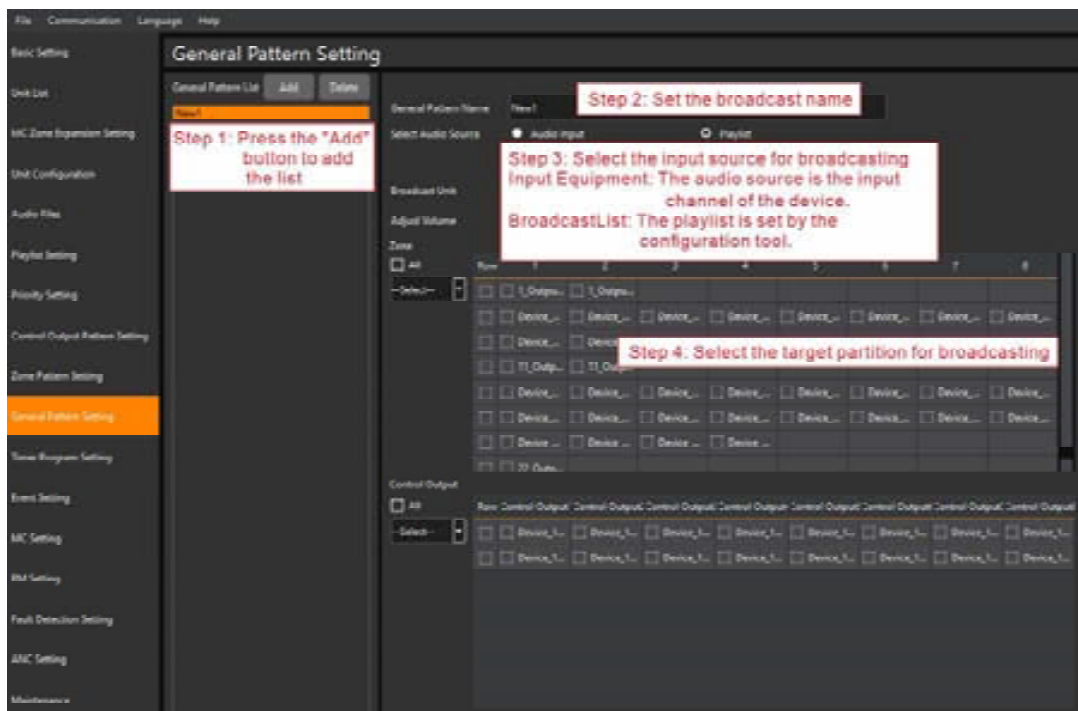

4.2.3 Set the timer to start broadcasting

On the "Timer Program Setting" interface, set the Timer Program name, select "General Pattern", set "Timer type", "Start Date", etc. When the unit reaches the specified time, it will start the specified broadcast pattern.

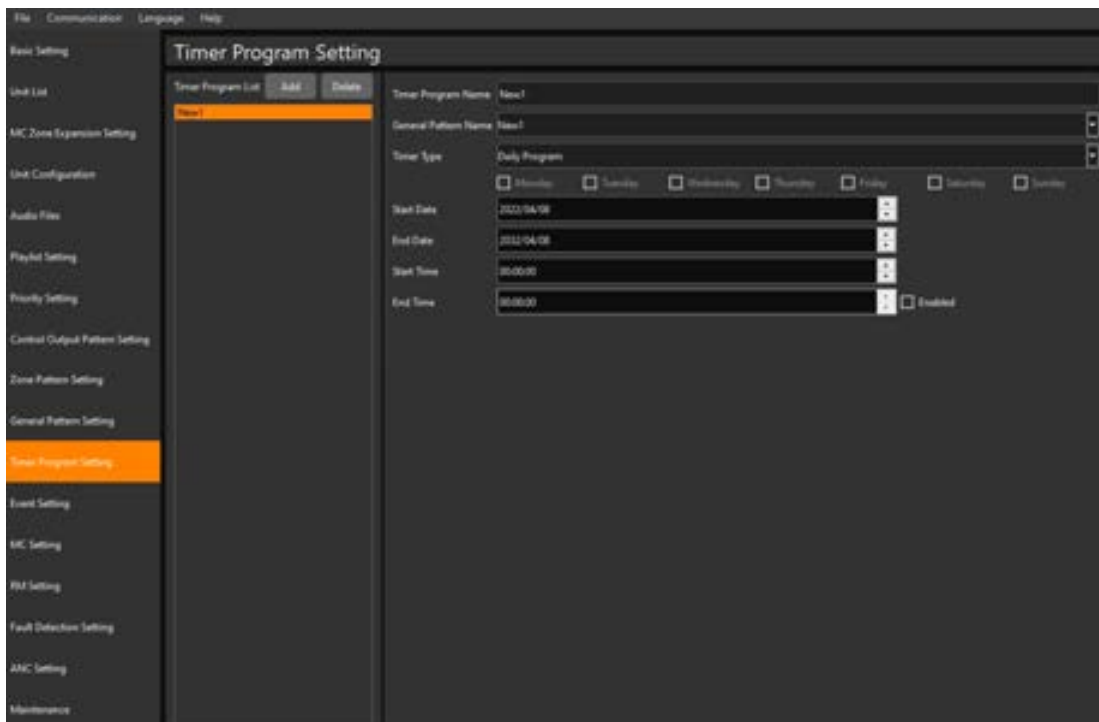

4.2.4 Set Event to start broadcasting

On the "Event Settings" interface, set the "Event name", select "General Pattern", and select "Control Input" signal. When the control input of the unit is triggered, the specified general pattern will be activated.

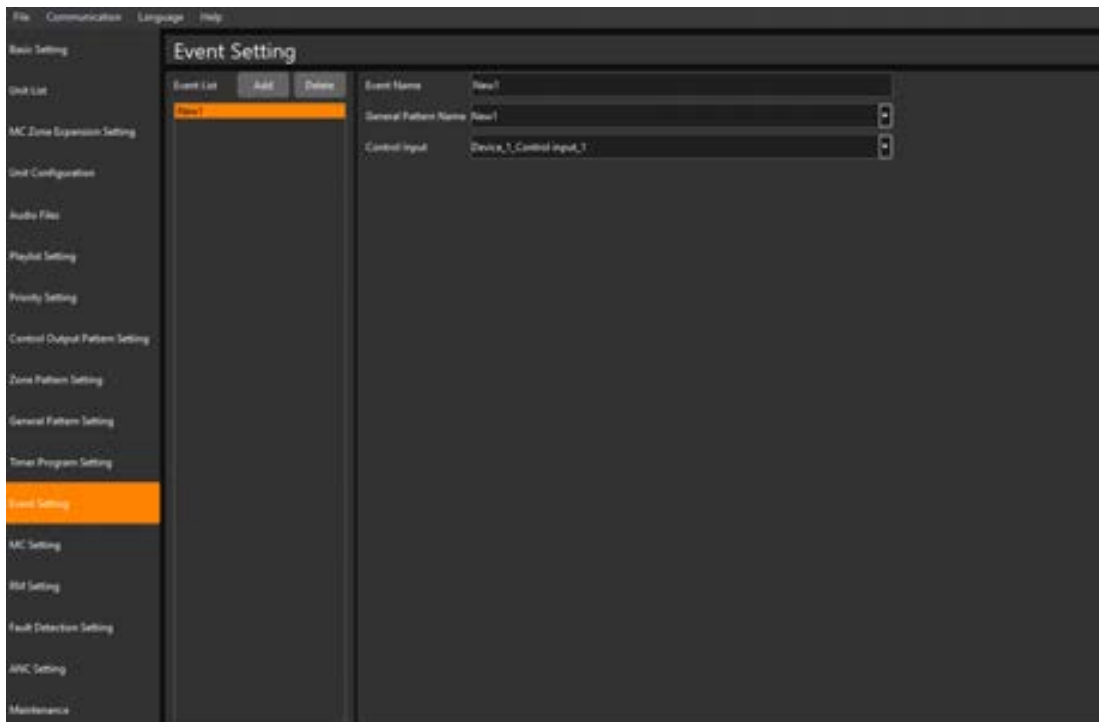

4.2.5 Set Preset-Key to start broadcast

On the "MC Settings" interface, you can set the general pattern corresponding to the [Preset 1]-[Preset 3] keys of the Matrix Controller. Press the unit's [Preset 1] - [Preset 3] key to start the specified general pattern.

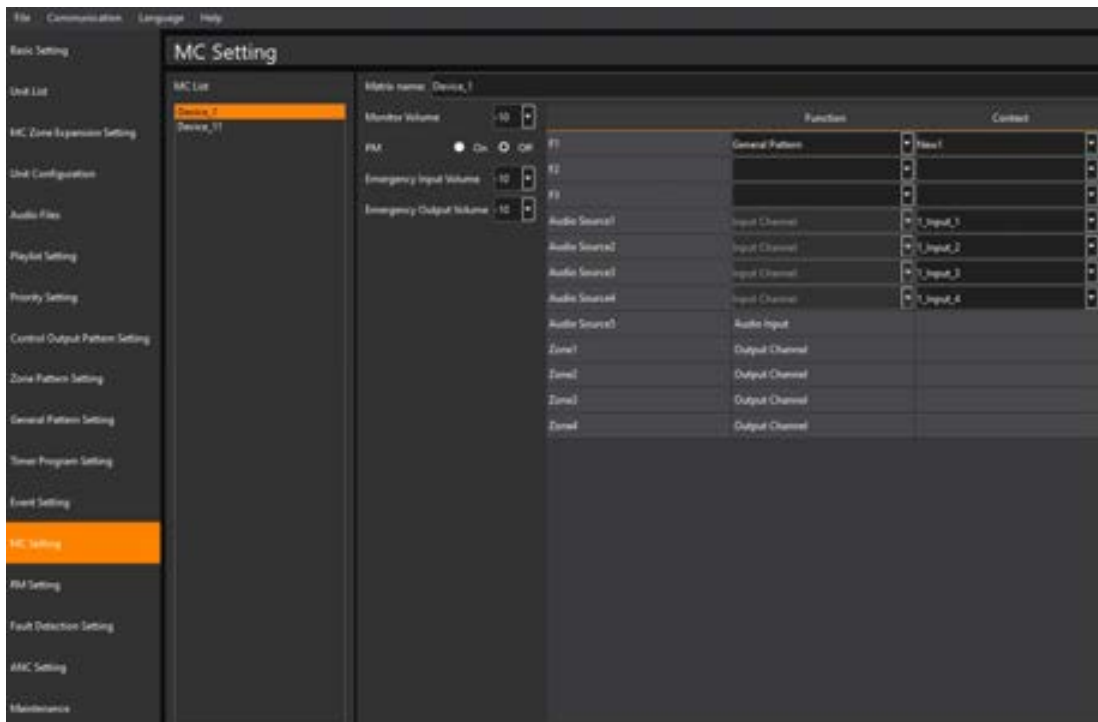

4.2.6 Set Remote Microphone function

On the "RM Settings" interface, you can configure the remote microphone.

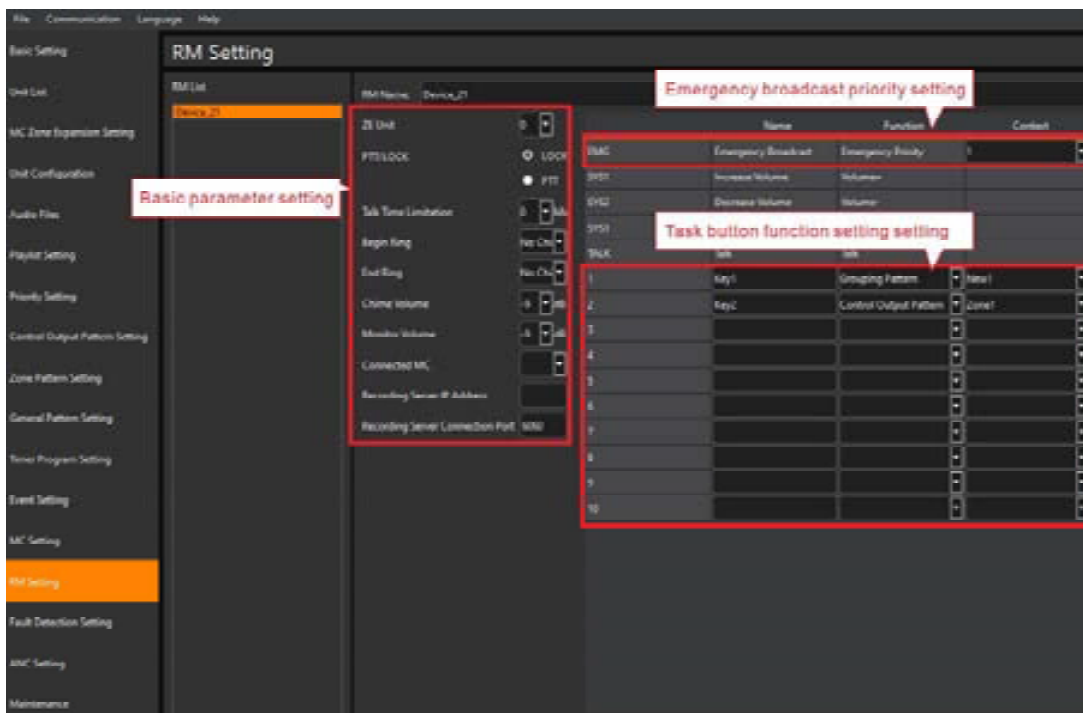

Basic parameter setting	Extension unit setting	Set the number of extension units connected to the remote microphone, and support up to 9 extension units.
	PTT/LOCK	PTT mode: When broadcasting, press the selection key first, and then continue to hold the Broadcast key, then you can initiate a call. Release the Broadcast key to end the broadcast. LOCK mode: When broadcasting, press the selection key first, then press the Broadcast key to initiate a call. Press the Broadcast key again to end the broadcast.
	Talk Time Limitation	Set the duration of the broadcasting, after the time, the unit will automatically end the broadcast. When the time limit is set to 0, the speaking time is not limited, and the broadcasting ends manually.
	Pre-announcement tone settings (Begin Ring/End Ring)	Set the unit to start broadcasting and end broadcast pre-announcement tone, when set to "No chime", there is no pre-announcement tone;
	Pre-announcement tone volume	The volume configuration of the start and end pre-announcement tone.
	Monitor volume	The output volume configuration of the microphone monitor speaker.
	Connected MC	It is required to select one of Matrix Controller for activating playlist.
EMERGENCY Broadcast Key	EMERGENCY Priority	Set the broadcast priority of the EMERGENCY Broadcast key of the remote microphone, the priority range is 1 ~ 128;
Task key function setting	General pattern	Select the General Pattern, the corresponding list shows the preset pattern set on the VX-1000 "General Pattern Setting" interface. After selecting the corresponding general pattern, press the corresponding key to execute the general pattern; press the key again to end the general pattern.
	Grouping pattern	Select the zone. The corresponding list shows the zone list set on the VX-1000 "Zone Pattern Setting" interface. After setting the zone pattern, press the corresponding key and then press the Broadcast key to initiate a microphone broadcast.
	Control output pattern	Select the control output pattern. The corresponding list shows the control output list set on the VX-1000 "Control Output Pattern Setting" interface. After setting the control output pattern, press the corresponding key, the corresponding control output is closed, and press the key again, the corresponding control output is disconnected.
	Monitor Function	Select the monitor function, corresponding to the unit output list displayed in the list. After configuring the monitoring output, press the corresponding key, the microphone monitor speaker plays the audio of the corresponding output, and press the key again to end the monitoring output.
	Failure Detection	Select Failure Detection and the Remote Microphone [Fault Information] screen will display a list of amplifiers configured with the VX-1000. When the microphone detects an amplifier fault, it will indicate accordingly.
	Trigger mode	Select the trigger mode, the function of the corresponding key for the remote microphone is the corresponding Matrix Controller unit selected in the VX-1000 Setting Software (the key trigger task needs to be configured on the SIP server). Pressing the corresponding key will trigger the microphone to initiate a broadcast.

4.2.7 Upload configuration

After the parameters are modified and saved, you must click [Communication]-[Upload], check the relevant unit in the pop-up dialog box, and then click the "Upload" button to upload the configured data file to the specified unit to take effect.

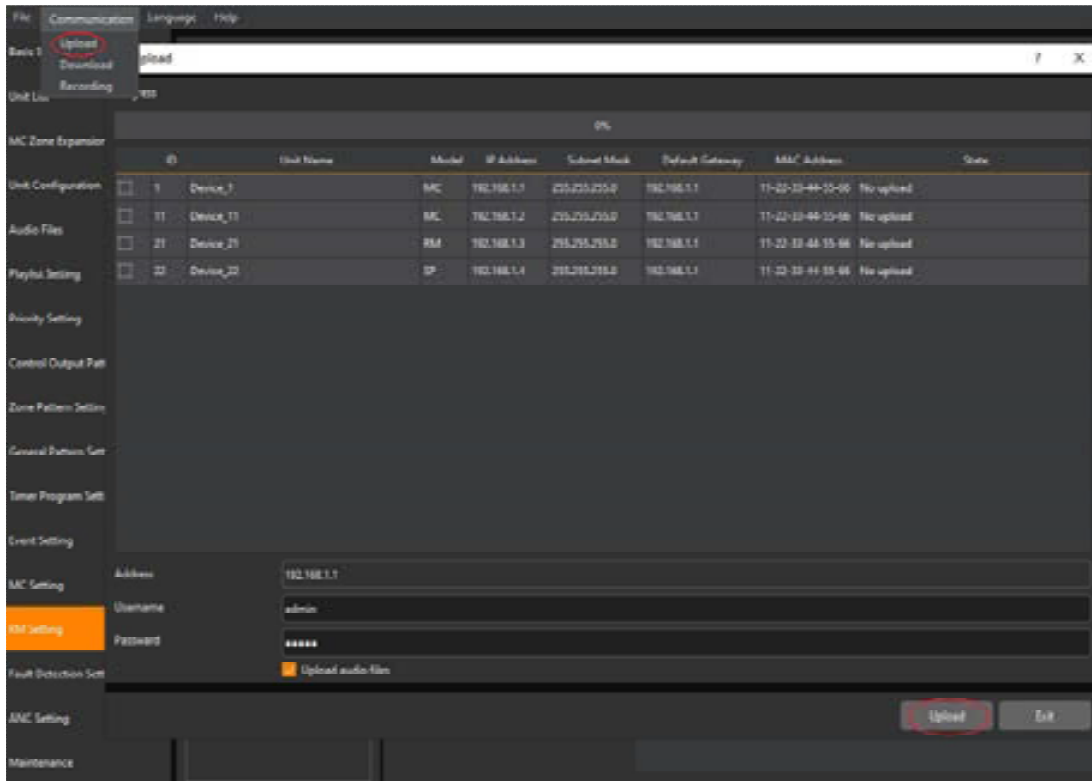

4.3 Initiate broadcast

4.3.1 Audio broadcasting

- (1) Rotate the [OPERATE Key] to select the target input (4 audio inputs, only single selection), press the [OPERATE Key] to confirm the selection ;

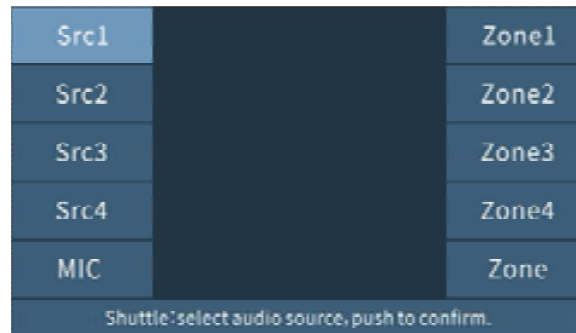

- (2) Rotate the [OPERATE Key] or press the corresponding partition key to select the target output (support multiple selection), press the [OPERATE Key] to confirm the selection ;

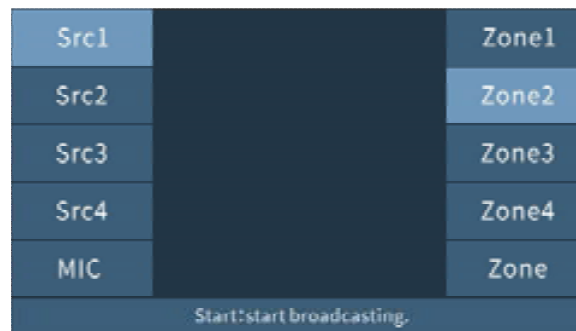

- (3) Press the [START Key] to start broadcasting.

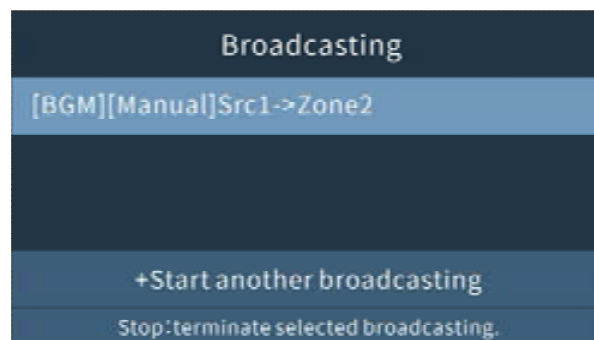

- (4) Additional broadcasting (maximum support for simultaneous 4-channel broadcasting) :
- iii. Rotate the [OPERATE Key] on the interface during the broadcast, select "Add broadcast", and press the [OPERATE Key] to confirm the selection.
 - iv. Select the target input and output (the operation method is the same as above), press [START Key] to initiate the second broadcast.

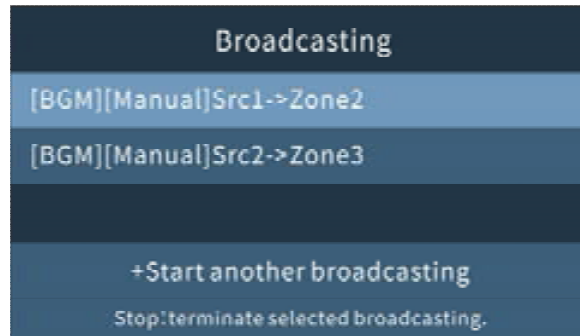

- (5) Stop broadcasting: Rotate the [OPERATE Key] to select the corresponding broadcast task, and press the [STOP Key] to end the corresponding broadcast.

4.3.2 Paging microphone broadcasting

- (1) Take off the handheld microphone, and then rotate the [OPERATE Key] or press the corresponding partition key to select the target output (multiple selection is supported), press the [OPERATE Key] to confirm the selection.

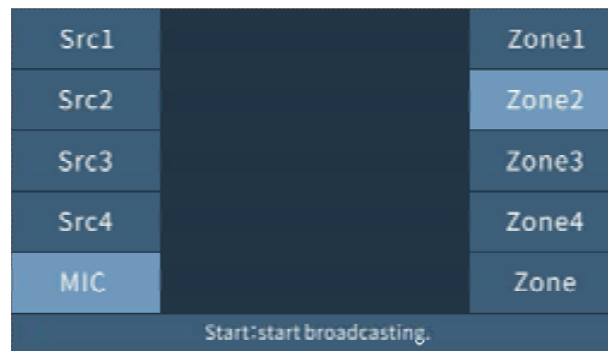

- (2) Press the [START Key] to start broadcasting. At this time, press the key on the left side of the microphone to start voice shouting.

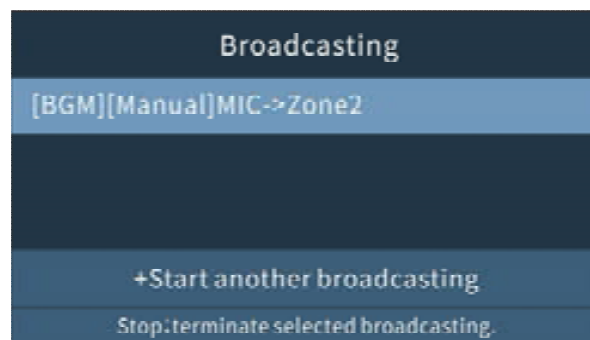

- (3) Release the key on the left side of the handheld microphone, and the broadcast sound output stops.
- (4) Press the [STOP Key] to stop broadcasting.

【Note: Please select "On" of PM in "MC Setting" of VX-1000 Setting Software in advance】

4.3.3 Preset broadcasting

- (1) Press the device [preset 1/2/3 key], the corresponding preset status light is green, and the preset broadcast set by the VX-1000 Setting Software is played ;
- (2) Press the corresponding [preset 1/2/3 key] again to end the preset broadcast, the corresponding preset status light is off.

4.3.4 Emergency broadcasting

External fire alarm broadcasting :

- (1) Press [EMERGENCY Key], the key light is steady red, and enter the emergency broadcast state.
- (2) Rotate the [OPERATE Key] to select the target input (4 audio inputs, only single selection), press the [OPERATE Key] to confirm the selection.
- (3) Rotate the [OPERATE Key] or press the corresponding partition key to select the target output (support multiple selection), press the [OPERATE Key] to confirm the selection.
- (4) Press 【START Key】 to start emergency broadcasting.
- (5) Press 【STOP Key】 to stop broadcasting.

Paging microphone emergency broadcasting :

- (1) Press the 【EMERGENCY Key】 , the key light is steady red, and the emergency broadcast state is entered.
- (2) Take off the paging microphone, and then rotate the [Job key] or press the corresponding partition key to select the target output (multiple selection is supported), and press the [OPERATE Key] to confirm the selection.
- (3) Press [START Key] to start broadcasting.
- (4) Press the key on the left side of the microphone to start to announce; release the key on the left side of the paging microphone, the output of the broadcast sound stops.
- (5) Press 【STOP Key】 to stop broadcasting.

4.3.5 CPU OFF Analog line broadcasting

- (1) Remove the handheld microphone and pull the "CPU" switch to the "OFF" state. The CPU OFF status light is steady red, and emergency broadcast begins.
- (2) Press the key on the left side of the paging microphone to start the broadcast, the microphone broadcast will be played in all zones.
- (3) Release the left key of the paging microphone, the broadcast sound output stops. Pull the "CPU" switch back to the "ON" state, the CPU OFF status light goes out, and the analog line broadcast is stopped.

4.4 Monitoring

- (1) Press the [AUDIO MONITOR Key], the monitor status light is steady green, and the device enters the monitor state.
- (2) Rotate the [OPERATE Key] to select the monitor input audio source or zone output audio (Note: only one target can be monitored at the same time).

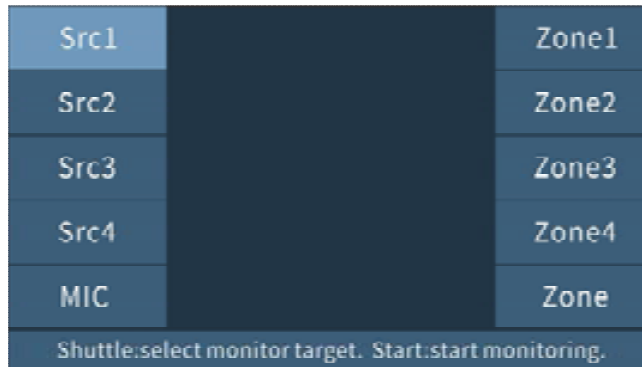

- (3) Press the [START Key] to start monitoring, the built-in monitoring speaker plays the target audio for monitoring.

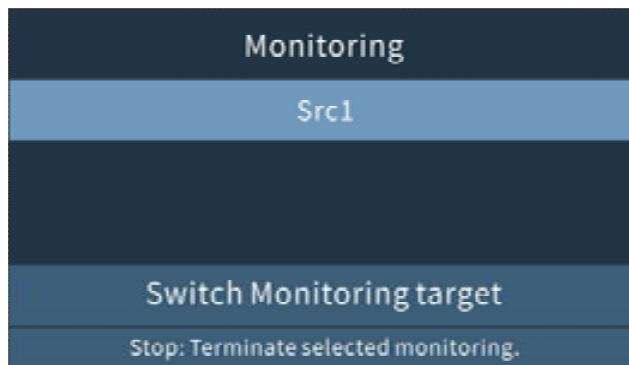

- (4) Switching the monitoring object: In the "Monitoring" interface, rotate the [OPERATE Key] to select "Switching the monitoring object" and press the [OPERATE Key] to confirm the selection. Rotate the [OPERATE Key] again to select the monitoring target, press the [START Key] to start monitoring.
- (5) End monitoring: Press [STOP Key] to end monitoring the target, and the device is still in monitoring state. Press [AUDIO MONITOR Key] again, the status light of the AUDIO MONITOR Key goes out, and the monitor state is exited.

4.5 System menu

4.5.1 Volume Adjustment

- (1) Press the [MENU Key] to enter the system menu interface, rotate the [OPERATE Key], select the "Volume adjustment" module, press the [OPERATE Key] to confirm the selection.

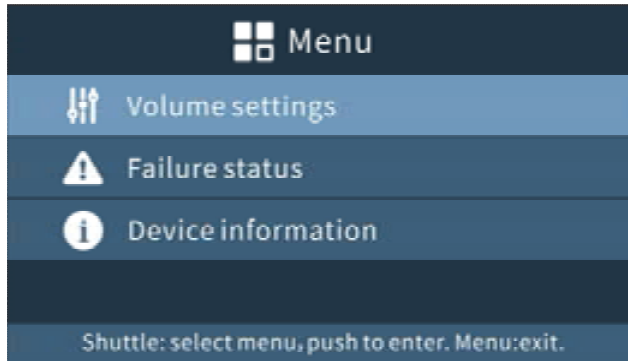

- (2) Rotate the [OPERATE Key] to select the volume of the target area, and press the [OPERATE Key] to confirm the selection. Continue to rotate the [OPERATE Key] to adjust the target volume.

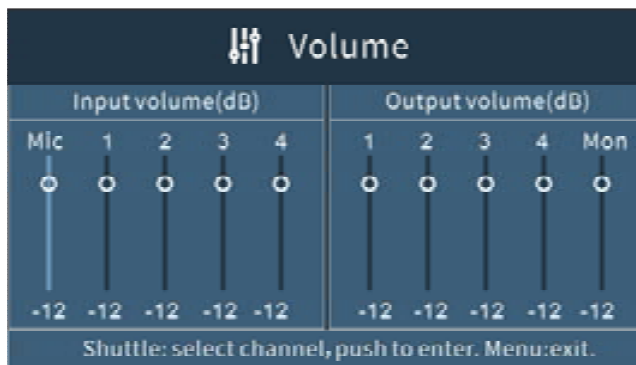

- (3) Press [MENU Key] to save the current volume.

4.5.2 Fault state

- (1) Press the [MENU Key] to enter the system menu interface, rotate the [OPERATE Key], select the "Fault status" module, and press the [OPERATE Key] to confirm the selection. View equipment failure status.

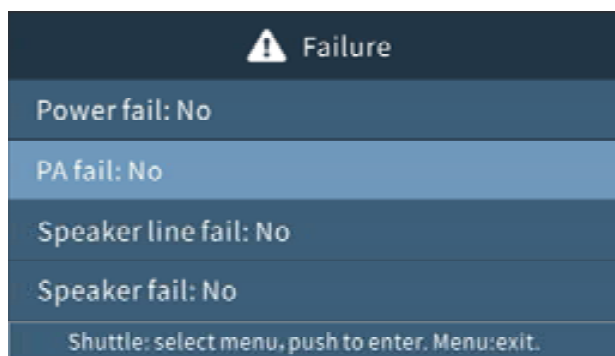

4.5.3 Device Information

- (1) Press the [MENU Key] to enter the system menu interface, rotate the [OPERATE Key], select the "Device Information" module, and press the [OPERATE Key] to confirm the selection. View device IP address, firmware version, MAC address and other information.

5 TROUBLESHOOTING

5.1 Troubleshooting

5.1.1 Manually initiate a sound source broadcast without sound?

- (1) Check whether the device audio source input interface or auxiliary audio source input interface has audio input. Press the monitor key to monitor the audio source input channel, whether there is sound output from the left speaker on the front panel;
- (2) Check whether the output interface of the device group is properly connected. Press the monitor key to monitor the target partition channel, whether there is sound output from the speaker on the left side of the front panel; if there is sound, check whether the signal light of the channel of the power amplifier unit corresponding to the Peering Frame is always on; check the power input and output interface and power amplifier interface of the matrix and Peering Frame Whether the connection cable is connected normally; whether the output wiring of the matrix speaker circuit is normal;

5.1.2 Press the self-check key, the LED light on the panel of the Peering Frame does not respond?

Check the matrix controller and the Peering Frame to check whether the interface is well connected with the network cable;

5.1.3 In the main interface of the matrix controller UI, the displayed channel name does not match the configured name?

Check whether the device has uploaded the parameters configured in the matrix configuration tool;

5.1.4 Press the manual key to initiate the broadcast, and there is no response when pressing the shuttle key?

Check whether the monitor status light of the device is green, if it is green, the device enters the monitor state, and the broadcast cannot be initiated at this time; press the monitor key to exit the monitor state and initiate the broadcast again;

5.1.5 When the server is offline, the time display is abnormal?

This situation may be caused by the exhaustion of the battery of the device. Please replace the battery at the J8 position in the product (Note: This operation must be performed by a professional). The specific steps are as follows:

Required tools: Phillips screwdriver (or electric screwdriver), tweezers.

Step 1 : Using a Phillips screwdriver (or electric screwdriver), remove all 9pcs of M3*5 countersunk countersunk screws on the side and back of the device and remove the upper cover.

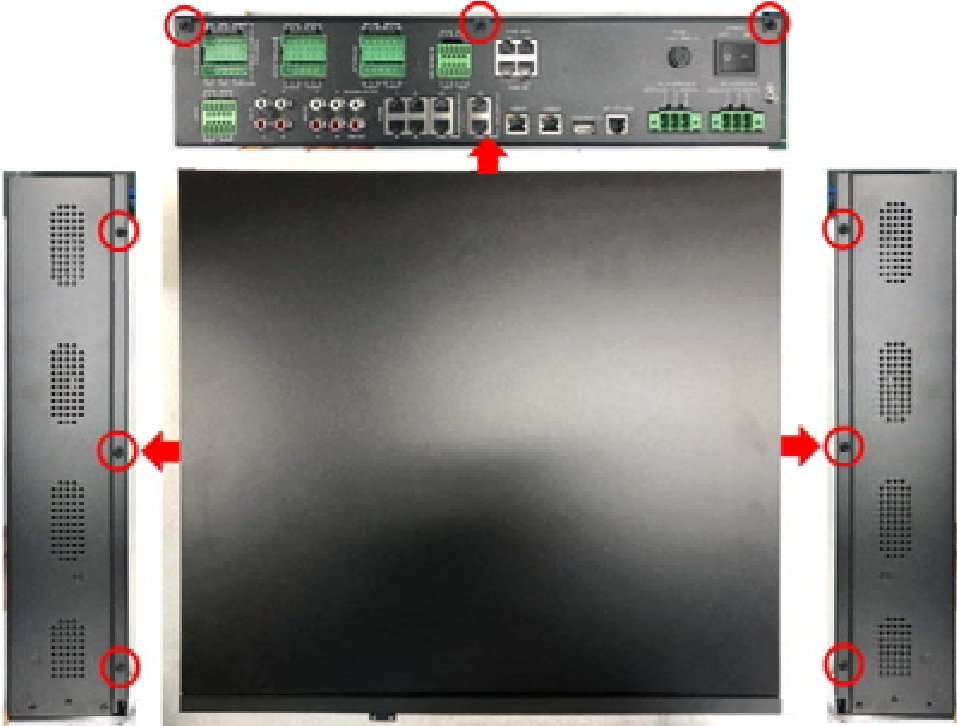

Step 2 : Use a Phillips screwdriver (or electric screwdriver) to remove the four M3*4 countersunk cross screws on the right side bracket of the device and remove the right side bracket.

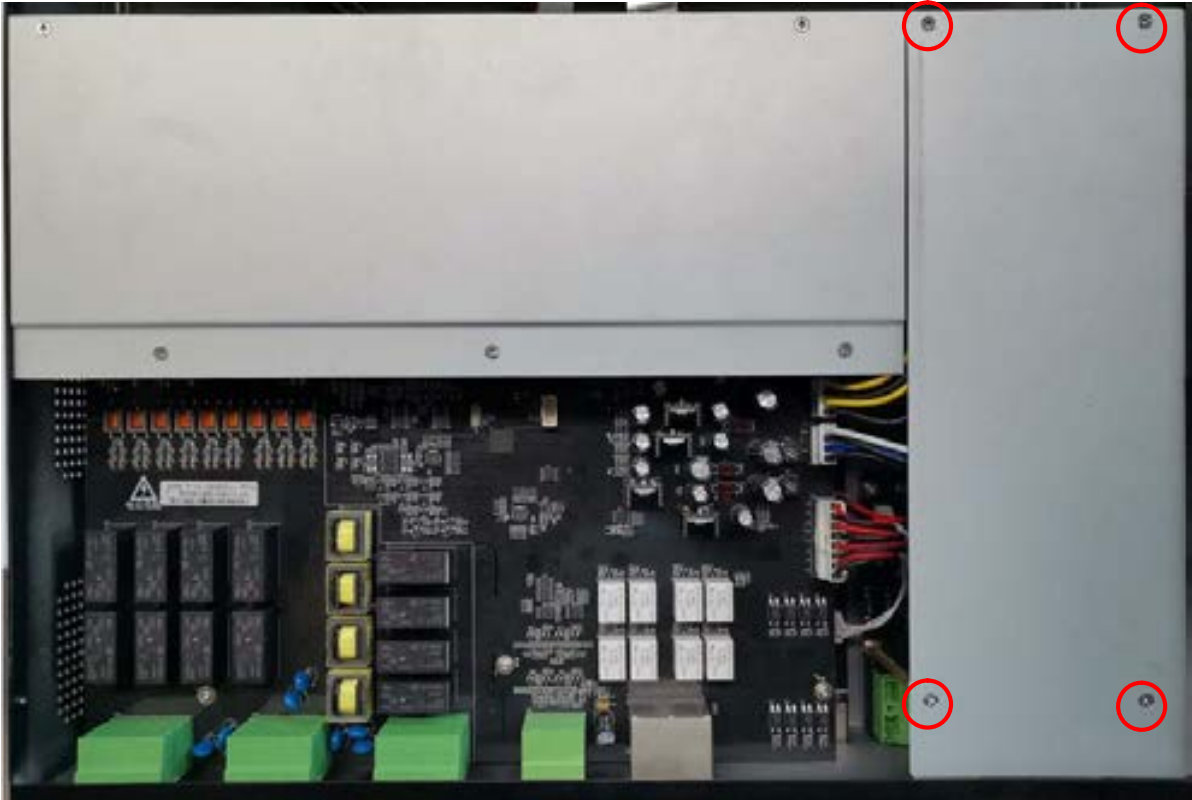

Step 3: Locate the button battery at the J8 position on the lower motherboard, and use tweezers to remove the battery and replace it.

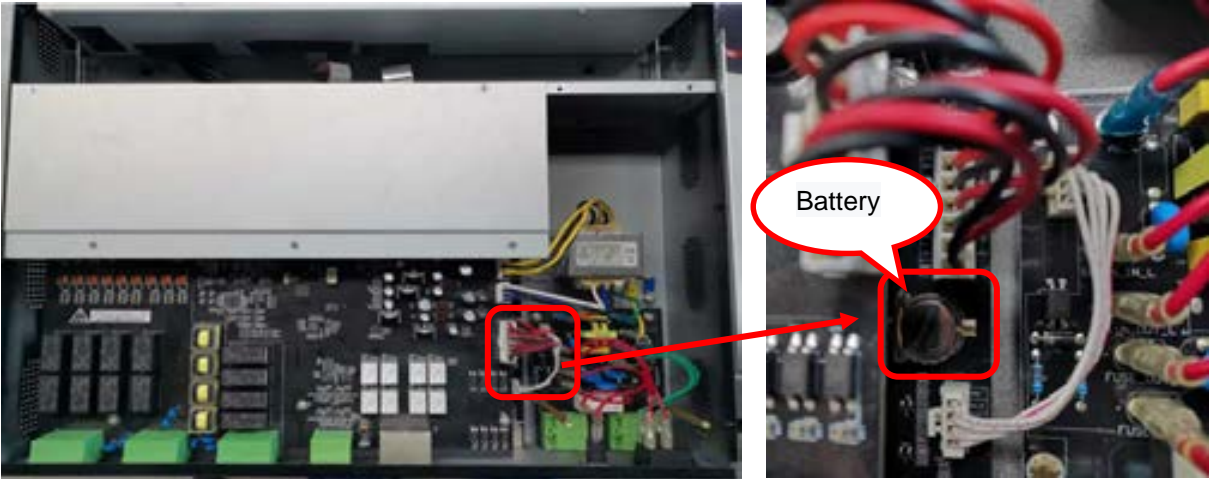

Step 4 : Reinstall the removed bracket and cover.

6 APPENDIX

6.1 Specification

6.1.1 VX-1000MC Matrix Controller

Model		VX-1000MC
Power Supply		AC POWER IN A/B : AC220-240V, 50Hz/60Hz, European standard terminal
Power Consumption		16.65W
Audio Input		4 Channels, European standard terminal, Balanced, Input impedance 10K Ω , Rated input 0dB
Auxiliary audio input		4 Channels, RCA Terminal, Unbalanced, Input impedance 10K Ω , Rated input 0dB ; Mixing with audio input interface
Amplifier Interface		4 Channels, RJ45 Interface
Auxiliary audio output		4 Channels, RCA Terminal, Unbalanced, maximum 0dB
Recording output		1 Channels, RCA Terminal, Unbalanced, maximum 0dB
Noise detection Microphone input		4 Channels, European standard terminal, Balanced, Rated input 0dB
Control input		8 Channels, RJ45 Interface
Control output		8 Channels, RJ45 Interface
Attenuator control output		4 Channels, European standard terminal
Speaker line output		4 Channels, European standard terminal
Internal storage capacity		1GB
Network	Interface	RJ45 Interface, 10BASE-T/100BASE-TX
	Protocol	SIP、NTP、HTTP、RTP、FTP
Audio features	Frequency response	Analog audio : 20~20,000Hz \pm 3dB Network audio : 40~18,000Hz \pm 3dB Built-in files : 40~18,000Hz \pm 3dB
	Distortion	\leq 1%
	S/N	$>$ 70dB
Functions	Loop detection	Open circuit, short circuit, ground
	Fault detection	Main power failure, backup power supply failure, power amplifier failure, Peering Frame failure
Working temperature		-10 $^{\circ}$ C~+55 $^{\circ}$ C
Working humidity		\leq 90%, not condensing
Material		Panel: Aluminum profile surface oxidation treatment, black
Size		493(width) \times 88(height) \times 396(depth)mm
Weight		6.96kg
Accessories		Terminals (hole) (2EDGK-5.08-06P) :6pcs Terminals (hole) (15EDGK-3.81-06P) :4pcs Foot pad (FF-7) :4pcs Power cable :2pcs (Only when a single device is shipped) Button Battery (CR1220 3V) :1pcs Fuse (6S1A) :1pcs

6.1.2 VX-1000PF Peering Frame

Model	VX-1000PF
Power Supply	AC POWER IN A/ B : AC220V-240V, 50Hz/60Hz, European standard terminal
Power Consumption	3.5W (When the main power port & power amplifier unit is not inserted)
Digital Amplifier Unit slot	4 channels
Stand-by Amplifier Unit slot	1 channel
Operation temperature	-10°C~+55°C
Operation humidity	≤90%, not condensing
Material	Panel : Aluminum profile surface oxidation treatment, black
Size	493(width)×177(height)×395(depth)mm
Weight	8.77kg
Accessories	Foot pad (FF-7) :4pcs Power cable :2pcs (Only when a single device is shipped) Fuse (6S15A) :1pcs

6.1.3 VX-1500DA/VX-1250DA Power Amplifier Module

Model	VX-1250DA	VX-1500DA
Power Supply	AC220V-240V, 50Hz/60Hz (Supply from VX-1000PF)	
Amplifier	Class D amplifier	
Power consumption	27.7W (standby mode) 255W (Rated output status)	28.2W (standby mode) 505W (Rated output status)
Rated output	250W	500W
Frequency response	20~20,000Hz ±3dB	
Distortion	<1%	
S/N	>90dB	
Cooling method	Forced air cooling	
Working temperature	-10°C~+55°C	
Working humidity	≤90%, not condensing	
Material	SECC	
Size	82.5(width)×128.7(height)×316(depth)mm	
Weight	2.035kg	2.085kg
Accessories	Terminals (hole) (2EDGKM-5.08-2P) :1pcs	

Traceability Information for Europe

Manufacturer:

TOA Corporation

7-2-1, Minatojima-Nakamachi, Chuo-ku, Kobe, Hyogo, Japan

Authorized representative:

TOA Electronics Europe GmbH

Suederstrasse 282, 20537 Hamburg, Germany

URL: <https://toa.com.sg/>