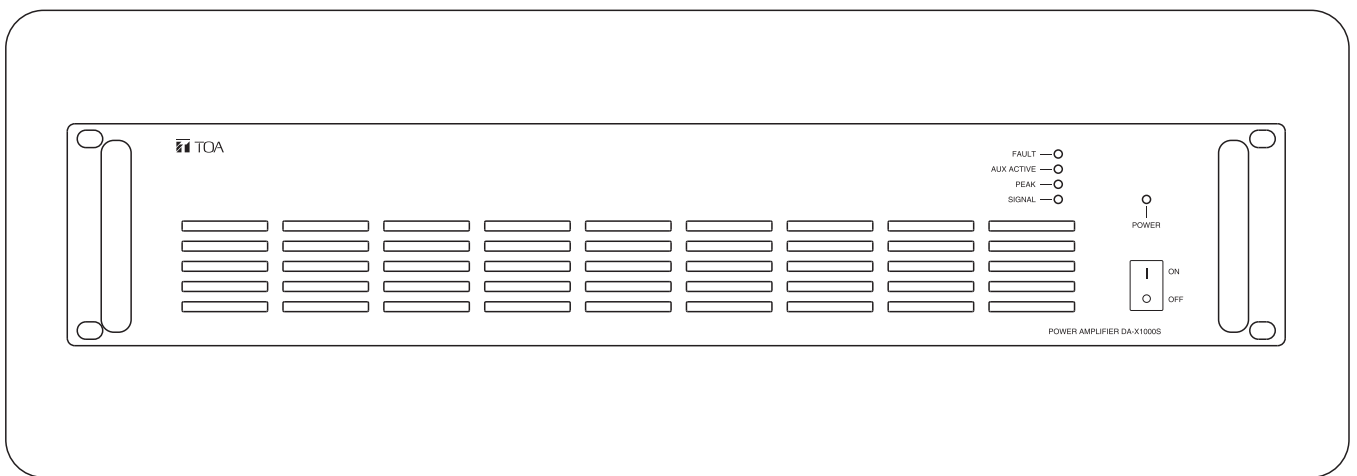

**POWER AMPLIFIER****DA-X1000S**

An all-pole mains switch with a contact separation of at least 3 mm in each pole shall be incorporated in the electrical installation of the building.

Thank you for purchasing TOA DA-X1000S power amplifier.

Before attempting to connect, operate or adjust this Amplifier, please read these instructions completely and carefully and save this Manual.

# TABLE OF CONTENTS

1.SAFETY INSTRUCTIONS .....	2
2.SUMMARY .....	4
3.FEATURES .....	4
4.USE NOTES .....	4
5.INSTALLATION NOTES .....	5
6.NAME AND FUNCTION OF EACH PART .....	6
6.1 FRONT PANEL .....	6
6.2 REAR PANEL .....	7
7.SETTING AND CONNECTION METHOD .....	8
7.1 SWITCH SETTING AND SPEAKER CONNECTION .....	9
7.1.1 DA-X1000S CONNECTION .....	9
8.CONNECTING METHOD OF THE DETACHABLE WIRING PLUG .....	9
9.LIST OF PROTECTION OPERATIONS .....	10
10.INSTALLATION OF FILTER SUPPORT AND FILTER .....	10
11.CLEANING OF FILTERS .....	11
12.DIMENSIONAL DRAWING .....	11
13.BLOCK DIAGRAM .....	12
13.1 DA-X1000S .....	12
14.DESCRPTION OF WIRING CONNECTION .....	13
14.1 PA LINK .....	13
14.2 PIN HOLE NUMBER AND LINE COLOR FROM NETWORK CRYSTAL HEAD .....	13
14.3 AUX INPUT .....	13
14.4 OUTPUT .....	13
15.SPECIFICATION .....	14
15.1 DA-X1000S .....	14
16.FUSE REPLACEMENT METHOD .....	15

# 1. SAFETY PRECAUTIONS

- Before installation or use, be sure to carefully read all the instructions in this section for correct and safe operation.
- Be sure to follow all the precautionary instructions in this section, which contain important warnings and/or cautions regarding safety.
- After reading, keep this manual handy for future reference.

## Safety Symbol and Message Conventions

Safety symbols and messages described below are used in this manual to prevent bodily injury and property damage which could result from mishandling. Before operating your product, read this manual first and understand the safety symbols and messages so you are thoroughly aware of the potential safety hazards.



## WARNING

Indicates a potentially hazardous situation which, if mishandled, could result in death or serious personal injury.

### When Installing the Unit

- Do not expose the unit to rain or an environment where it may be splashed by water or other liquids, as doing so may result in fire or electric shock.
- Use the unit only with the voltage specified on the unit. Using a voltage higher than that which is specified may result in fire or electric shock.

Do not cut, kink, otherwise damage nor modify the power supply cord. In addition, avoid using the power cord in close proximity to heaters, and never place heavy objects--including the unit itself -- on the power cord, as doing so may result in fire or electric shock.

- Be sure to ground to the safety ground (earth) terminal to avoid electric shock. Never ground to a gas pipe as a catastrophic disaster may result.

### When the Unit is in Use

- Should the following irregularity be found during use, immediately switch off the power, disconnect the power supply plug from the AC outlet and contact your nearest TOA dealer.

Make no further attempt to operate the unit in this condition as this may cause fire or electric shock.

- If you detect smoke or a strange smell coming from the unit
- If water or any metallic object gets into the unit
- If the unit falls, or the unit case breaks
- If the power supply cord is damaged (exposure of the core, disconnection, etc.)
- If it is malfunctioning (no tone sounds)
- To prevent a fire or electric shock, never open nor remove the unit case as there are high voltage components inside the unit. Refer all servicing to qualified service personnel.
- Do not place cups, bowls, or other containers of liquid or metallic objects on top of the unit. If they accidentally spill into the unit, this may cause a fire or electric shock.
- Do not insert nor drop metallic objects or flammable materials in the ventilation slots of the unit's cover, as this may result in fire or electric shock.
- Do not touch a plug during thunder and lightning, as this may result in electric shock.
- When replacing the fuse, be sure to use the supplied one. Using any other fuse than supplied may cause fire or electric shock.



## CAUTION

Indicates a potentially hazardous situation which, if mishandled, could result in moderate or minor personal injury, and/or property damage.

### When Installing the Unit

- Never plug in nor remove the power supply plug with wet hands, as doing so may cause electric shock.
- When unplugging the power supply cord, be sure to grasp the power supply plug; never pull on the cord itself. Operating the unit with a damaged power supply cord may cause a fire or electric shock.

- When moving the unit, be sure to remove its power supply cord from the wall outlet. Moving the unit with the power cord connected to the outlet may cause damage to the power cord, resulting in fire or electric shock. When removing the power cord, be sure to hold its plug to pull.
- Do not block the ventilation slots in the unit 's cover. Doing so may cause heat to build up inside the unit and result in fire. Also, periodically clean the ventilation slots of dust.
- Avoid installing the unit in humid or dusty locations, in locations exposed to the direct sunlight, near the heaters, or in locations generating sooty smoke or steam as doing otherwise may result in fire or electric shock.
- To avoid electric shocks, be sure to switch off the unit 's power when connecting speakers.
- Be sure to follow the instructions below when rack-mounting the unit. Failure to do so may cause a fire or personal injury.
- Install the equipment rack on a stable, hard floor. Fix it with anchor bolts or take other arrangements to prevent it from falling down.
- When connecting the unit 's power cord to an AC outlet, use the AC outlet with current capacity allowable to the unit.
- Rack-mounting screws are not supplied with the unit. Prepare them that are appropriate for the equipment rack.

### When the Unit is in Use

- Make sure that the volume control is set to minimum position before power is switched on. Loud noise produced at high volume when power is switched on can impair hearing.
- Do not operate the unit for an extended period of time with the sound distorting. Doing so may cause the connected speakers to heat, resulting in a fire.
- Contact your TOA dealer as to the cleaning. If dust is allowed to accumulate in the unit over a long period of time, a fire or damage to the unit may result.
- If dust accumulates on the power supply plug or in the wall AC outlet, a fire may result. Clean it periodically. In addition, insert the plug in the wall outlet securely.
- Switch off the power, and unplug the power supply plug from the AC outlet for safety purposes when cleaning or leaving the unit unused for 10 days or more. Doing otherwise may cause a fire or electric shock.

## 2. SUMMARY

DA-X1000S is 1 channel \*1000 W, Class D power amplifier with high output durable of constant voltage. It can be used as a residential area, schools, squares, high-speed rail way and other professional broadcast system after the sound drive amplification, using efficient switching power, strong output power.

## 3. FEATURES

- Can be installed in 2 U size space cabinet.
- Low power consumption, light weight.
- DA-X1000S transfers the INPUT signal from the rear panel to OUTPUT channel. The volume of the output signal can be adjusted by the input volume potentiometer.
- Electronic balanced input.
- Input terminals use detachable wiring plug and RJ45 connector that can be easily connected to VX-1000S system.
- Each channel is provided with a LED indicator showing the status of input and output, protection.
- Short circuit, overload and abnormal temperature rise, the output and load can be cut off by the built-in protection circuit.
- Internal information (power ON/OFF status, protection status, mode switching) is available.

## 4. USE NOTES

- This unit is using the power plug and appliance coupler to cut off the main power supply. Place the power plug or the appliance coupler in the most convenient position during the use. In order to facilitate the occurrence of danger, the power supply can be disconnected timely and accurately.
- Please place the input cable separately from the output cable, otherwise it may cause resonance.

- Please use the specified constant voltage loudspeaker. It may lead to the output power failure when connecting the loudspeaker beyond the specified voltage.
- There is a filter in front of the apparatus, please clean the filter regularly, if the filter is blocked, it may lead to abnormal heat dissipation.
- Please use in places where temperature-10~40°C humidity below 90% RH (no condensation) is present.
- When cleaning the equipment, be sure to break the power switch of the equipment first, then wipe it with a dry towel, and if you encounter more difficult stains, you can do so in these appropriate amount of neutral cleaning agent to clean the towel. Do not use gasoline, diluent, alcohol and other chemicals, otherwise it may cause deformation, discoloration and other conditions.
- This unit is a professional power amplifier. Professional personnel operation and trial adjustment are required.

## 5. INSTALLATION NOTES



**Attention:** When this apparatus is installed other cabinet except our special cabinet, please use screws with diameter of 5 mm or more than 12 mm in length. Otherwise, it may lead to personal injury.

- The attached power cable is special for this equipment. Do not use on other equipment.
- Please install this apparatus into the cabinet, need to ensure that the cabinet is fully ventilated, please remove all the back cover of the cabinet in advance.
- When installing into the cabinet, install on the ventilation panel above size 1U.
  - Install to the top and bottom of the cabinet.
  - Set up and down every 5 units.

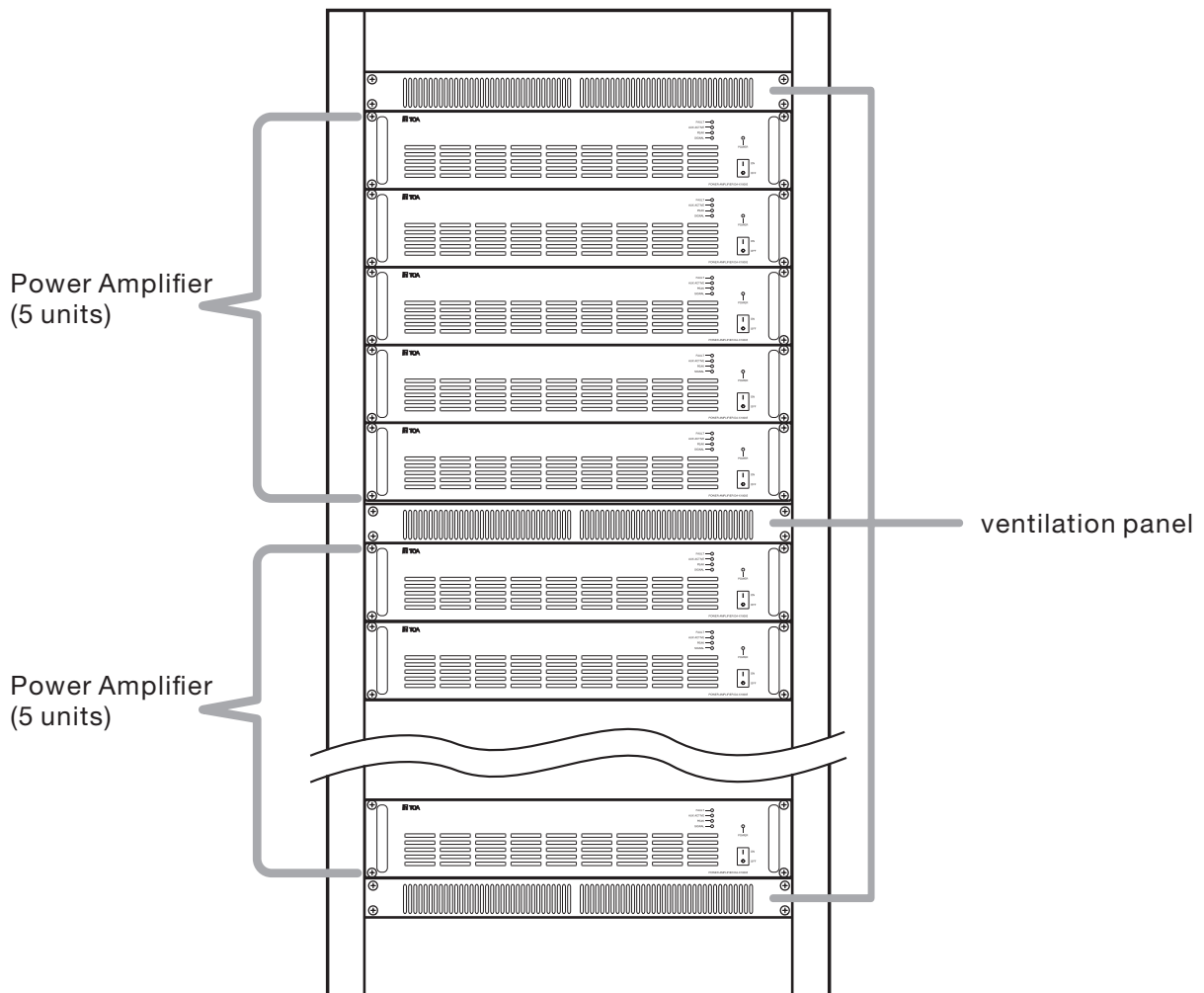

\*1 U = 44.5 mm (standard size)

## 6. NAME AND FUNCTION OF EACH PART

### 6.1 Front panel

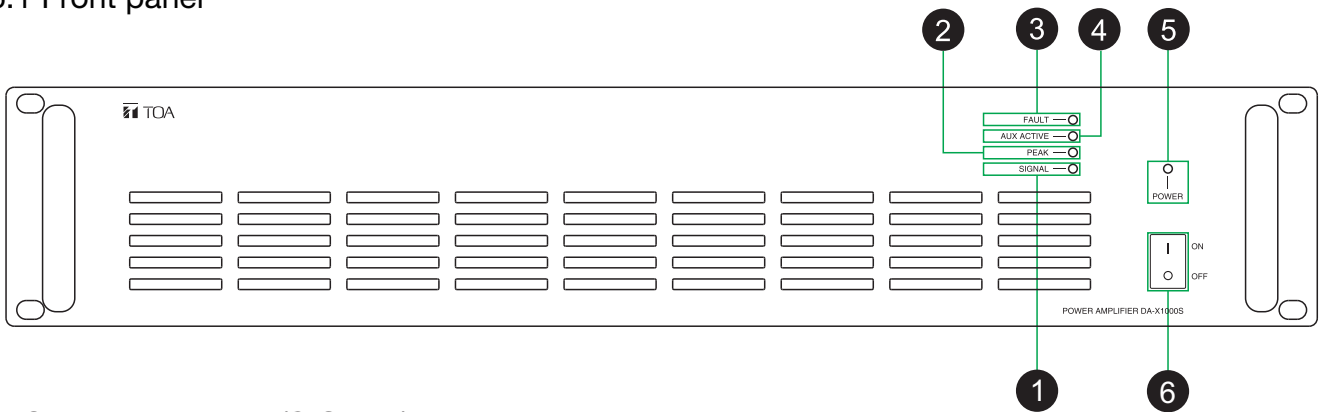

#### 1. Output indicators (SIGNAL)

These indicators show current signal output level.

2.

#### 3. Protect indicators (FAULT)

The red light flashes when the unit has short circuit, the orange light flashes when the unit has other faults.

#### 4. The AUX auxiliary signal input indication (AUX ACTIVE)

The orange light flashes when the ACTIVE is short connected, and when the AUX auxiliary signal is inputted.

#### 5. Power indicators (POWER)

The green light flashes when power of this device is on.

6.

### 6.2 Rear panel

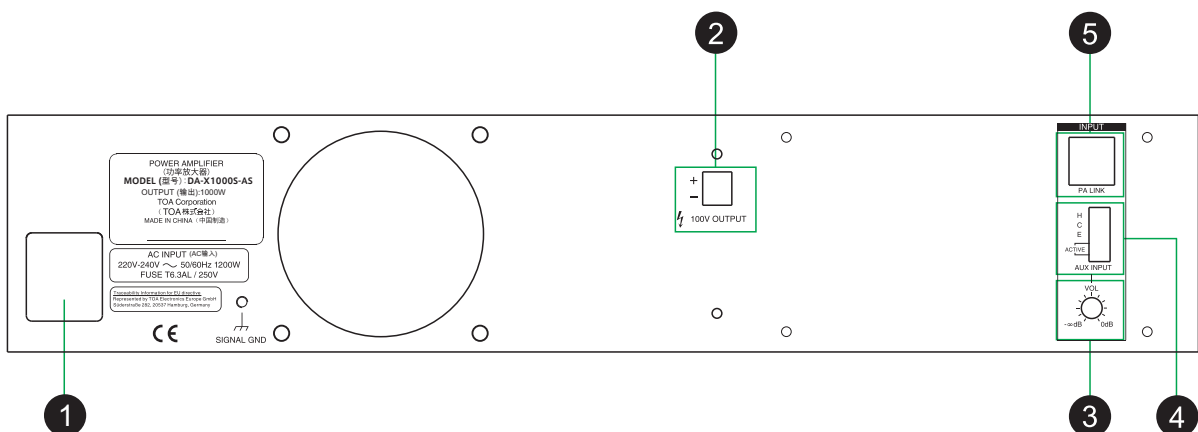

#### 1. AC power input connection (AC INPUT)

A correct capacity of fuse and power cable should be applied. Please make sure the value of fuse before replacing.

## 2. Volume controls (INPUT VOL)

The volume potentiometer adjusts the input level.

## 3. Signal input and signal switch controls (AUX INPUT)

The AUX auxiliary signal is outputted when the ACTIVE is short connected. When the ACTIVE is disconnected, the PA LINK signal is outputted.

## 4. RJ45 Network connector (PA LINK)

Start "PA LINK", DA-X AMP connects to VX-1000MC for use.

# 7. SETTING AND CONNECTION METHOD

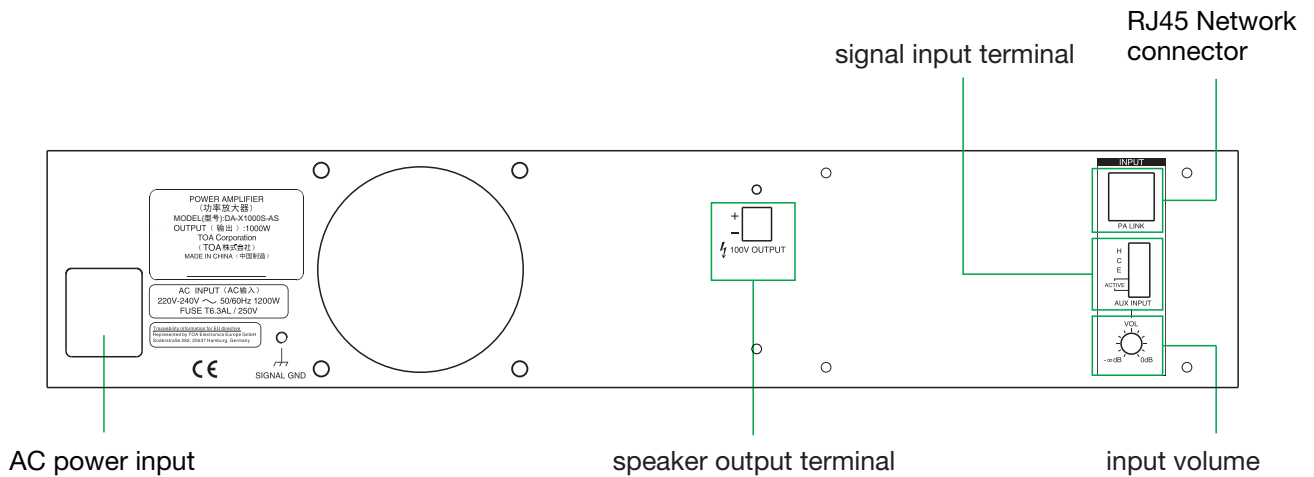

※ Figure is from DA-X1000S.

Step 1. Turn off the power supply.

Step 2. When the network port emergency signal switches to the AUX regular broadcast signal, the connector ACTIVE-A is short to the ACTIVE-B.

Step 3. Connect the speaker cable to the power amplifier output terminal via the detachable wiring plug.

Step 4. Turn off the power supply.

4-1. Peel the speaker wire cover (as attached image) about 7 MM. (Reference P10)

4-2. Connect the speaker cable to the attachment detachable wiring plug. (Reference P15)

4-3. Connect the detachable wiring plug to the power amplifier output terminal.

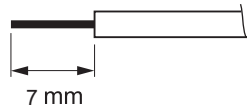

### Warning:

The metal part of the power amplifier output terminal has high voltage power. Please do not touch it directly by hand, otherwise it will causes electric shock and causes personal injury.

## 7.1 SWITCH SETTING AND SPEAKER CONNECTION

[1 input 1 output] (Factory Setting)

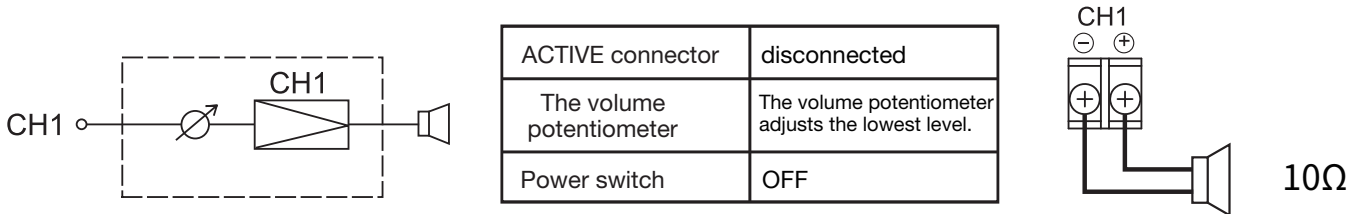

## 8. CONNECTION OF DETACHABLE WIRING PLUG

### Attentions

- Be sure to use the shield wire.
- Please pay attention to the exposed part of the wire. Please avoid tin plating.

When tying the wire, if the solder is damaged, it may increase the contact resistance, resulting in an abnormally increased temperature at the contact site.

Use the AWG 16-28 type for the wire type.

- Exposed part of the wire

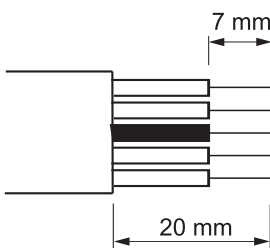

- Connection steps for the connector.

Step 1. Unscrew the screw in the terminal and insert the cable.

Step 2. Tighten the screw in the terminal.

※ Make sure the wire is not extended and elongated.

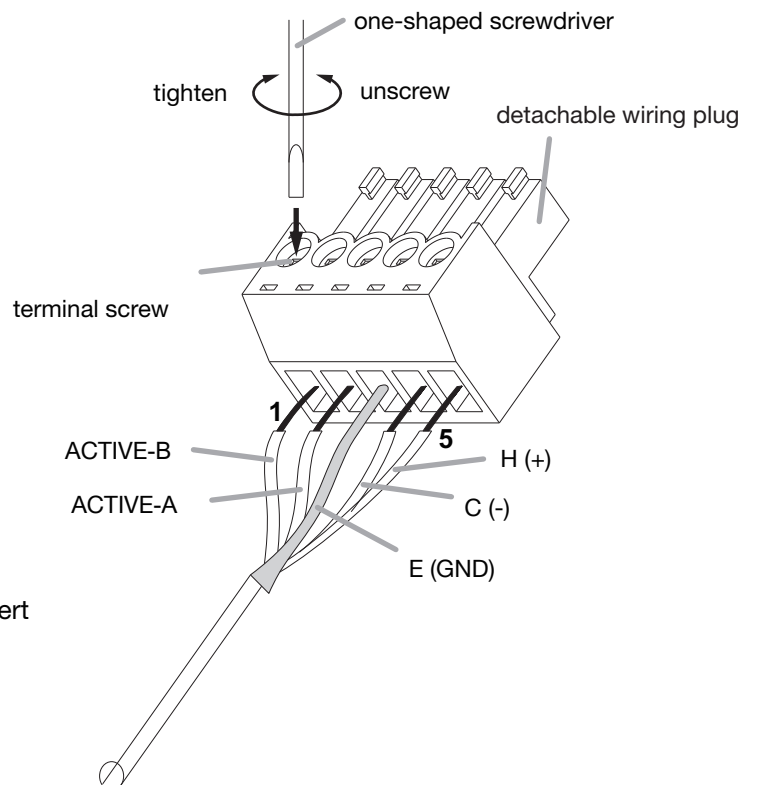



Remark

Recommended one-shaped screwdriver: the width of the blade mouth is about 3 MM.

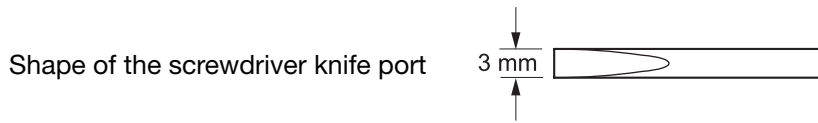

## 9. LIST OF PROTECTION OPERATIONS

Abnormal Condition	Protection	The operation display	Solution	Reset
Overload current	The current limiter starts in operation when the specified impedance is insufficient.	The peak or protection indicator is on.	Remove overload	Automatic reset after connecting the normal load.
Short circuit	The current limiter starts to run.	The operating indicator of the protection circuit is on.	Check the speakers, lines, etc. for a short circuit.	Cut off the power switch of this equipment. After normal load, power on.
Over-voltage, Under-voltage	The power amplifier protection circuit starts to run.	The protection indicator light is on.	Check the power board or amplifier board for damage, repair bad board.	
Heat-sink temperature of power amplifier (above 160 ° C)	Power board power-off protection.	The indicator of the corresponding channel will go off.	Check the ventilation condition and check if fan is overloaded.	After the temperature drops, it will be automatically reset.
Temperature rise of cooling board in power supply site (above 85 ° C)	The built-in power board unit that causes the temperature to rise stops working.			

## 10. INSTALLATION OF FILTER SUPPORT AND FILTER

Install the filter first, and then lock the filter support. Please check the below image.

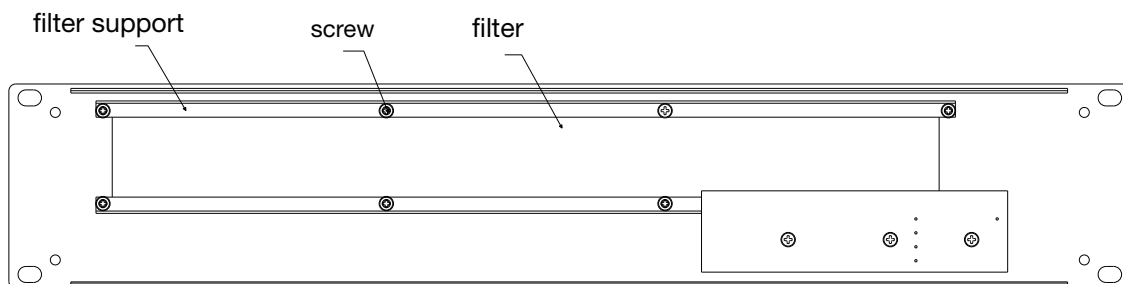

## 11. CLEANING OF FILTERS

Step 1 Turn off the power supply.

Step 2 Remove the ventilation panel.

Step 3 Unscrew the screw, remove the bracket.

Step 4 Remove the filter inside the panel.

Step 5 Remove the dust inside the filter.

Step 6 Lock the filter with the filter support.

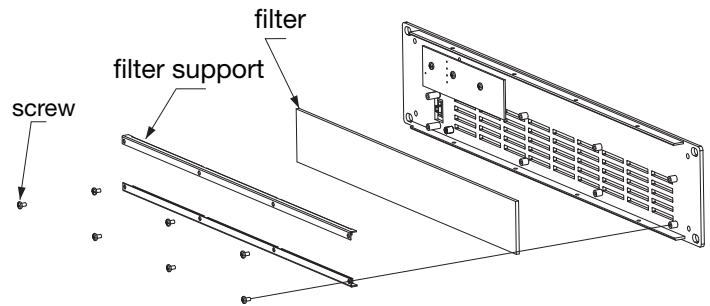

## 12. DIMENSIONAL DRAWING

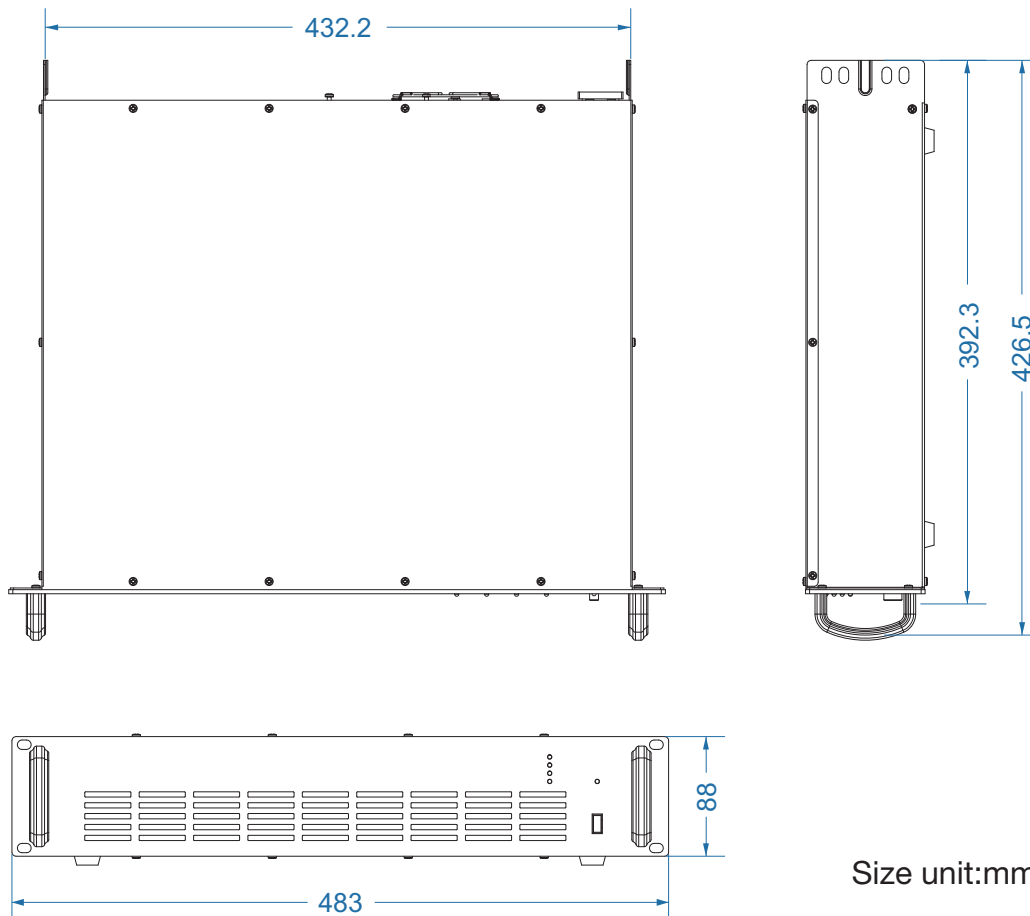

# 13.BLOCK DIAGRAM

## 13.1 DA-X1000S

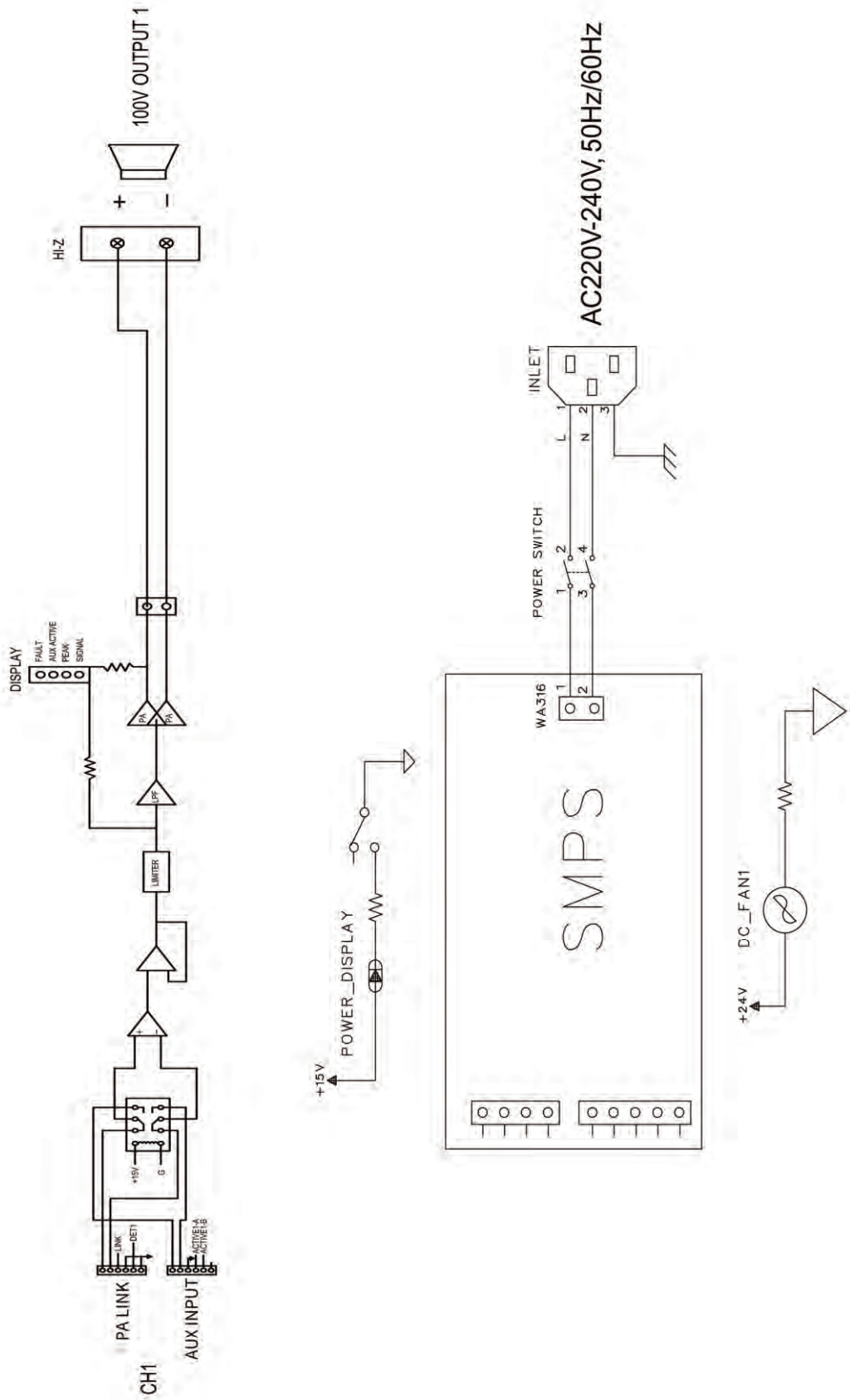

# 14. DESCRIPTION OF WIRING CONNECTION

## 14.1 PA LINK

### 14.1.1 RJ45 network input

1. H (+)
2. C (-)
3. LINK-PA
4. G (GND)
5. NC
6. DET (Protection port output control, HI-LEVEL for output protection, Lo-LEVEL for normal operation)
7. GND
8. GND

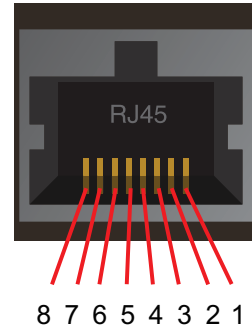

### 14.2 Pin hole number and line color from network crystal head

Connect to the control/monitor terminal

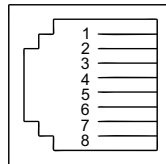
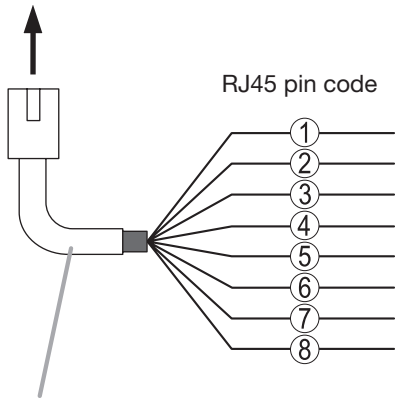

RJ45 pin code	line color (T568B)	line color (T568A)
①	orange/white	green/white
②	orange	green
③	green/white	orange/white
④	blue	blue
⑤	blue/white	blue/white
⑥	green	orange
⑦	dark brown/ white	dark brown/ white
⑧	dark brown	dark brown

Five class of air cables for LAN connection (CAT5-UTP)

### 14.3 AUX INPUT

1. Signal switching terminal ACTIVE-B
2. Signal switching terminal ACTIVE-A
3. G (GND)
4. C (-)
5. H (+)

(When ACTIVE-A and B are short connected, switch to euro block signal. when ACTIVE-A and B connection is cut , switch to RJ45 input signal.)

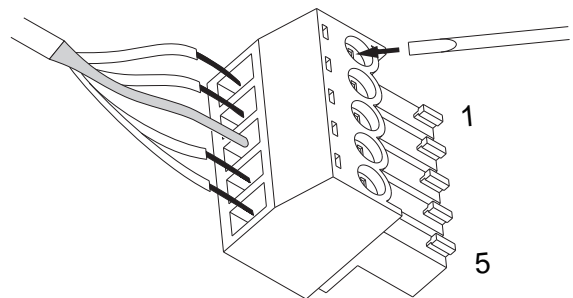

### 14.4 OUTPUT

1. - (100V Output)
2. + (100V Output)

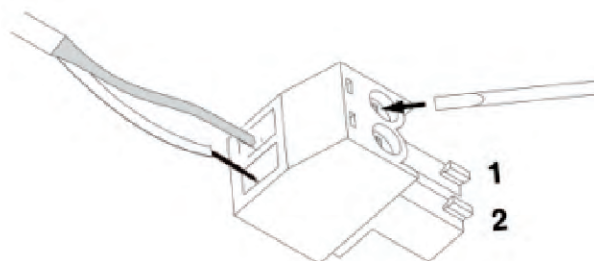

## 15. SPECIFICATIONS

### 15.1 DA-X1000S

Model Name	DA-X1000S
Power Supply	220V-240V~50/60Hz T6.3AL
Amplifier	Class-D Amplifier
Power consumption	30W(Standby mode), 1200W (rated output of 100V)
Input	1 Channel: PA LINK (dedicated configuration VX-1000MC use) 1 Channel: AUX INPUT (PIN 1,2,3) balanced input, (0dB (1V): input level adjusted to maximum, input impedance of 20K $\Omega$ )
Rated Output	1 Channel (2pin):1000W(100V,loading 10 $\Omega$ )
Frequency Response	110~16,000Hz $\pm$ 3dB
T.H.D	0.4% (1W),1%( rated output)
Protections	Overcurrent protection, under-voltage protection, over-voltage protection, overheat protection, short-circuit protection
S/N Ratio	90dB (A-weighted)
ACTIVE control input	The AUX auxiliary signal is outputted when the ACTIVE INPUT(pin4,5) is short connected. When the ACTIVE INPUT(pin4,5) is disconnected,the PA LINK signal is outputted
LED Indicator	POWER: power supply (green) X1; SIGNAL: signal (green) X1; PEAK: peak (red) X1; AUX ACTIVE: auxiliary input (orange) X1; FAULT: fault (red or orange) X1
Cooling	The system controls the fan for heat dissipation
Operating temperature	0 $^{\circ}$ C~+40 $^{\circ}$ C
Operating humidity	$\leq$ 90%, which is not condensed
Material	Black aluminum panel, electrolytic plate is sprayed black
Control	Panel: The power switch Rear panel: 1 Channel input volume adjustment knob
Dimensions	483 (L) X88 (H) X392 (D) mm
Weight	6.6KG (Net weight) 8.8KG (Gross weight)
Accessory	CE power cord X1; UK power cord X1; fuse T6.3AL X1(built-in); footpad X4; detachable terminal 2P X1; detachable terminal 5P X1

Necessary modifications are carried out without notice.

## 16.FUSE REPLACEMENT METHOD

Step 1. Turn off the power and unplug the power cable.

Step 2. Remove the power fuse box with a minus shape screwdriver.

Step 3. Remove the spare fuse from the power fuse box, replace the previously used fuse, and install it in the center.

Step 4. Reinstall the socket safety box, to install in place.

### Power outlet

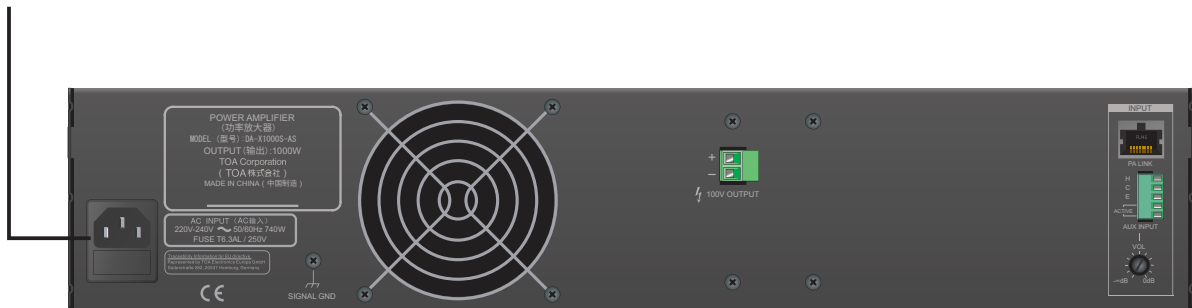

Remove the cover of the power fuse box with a minus shape screwdriver



Power fuse socket

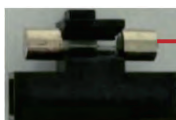

Install it in the center



The spare fuse

The previously used fuse

**Traceability Information for Europe**

Manufacturer:  
TOA Corporation  
7-2-1, Minatojima-Nakamachi, Chuo-ku, Kobe, Hyogo,  
Japan

Authorized representative:  
TOA Electronics Europe GmbH  
Suederstrasse 282, 20537 Hamburg,  
Germany